

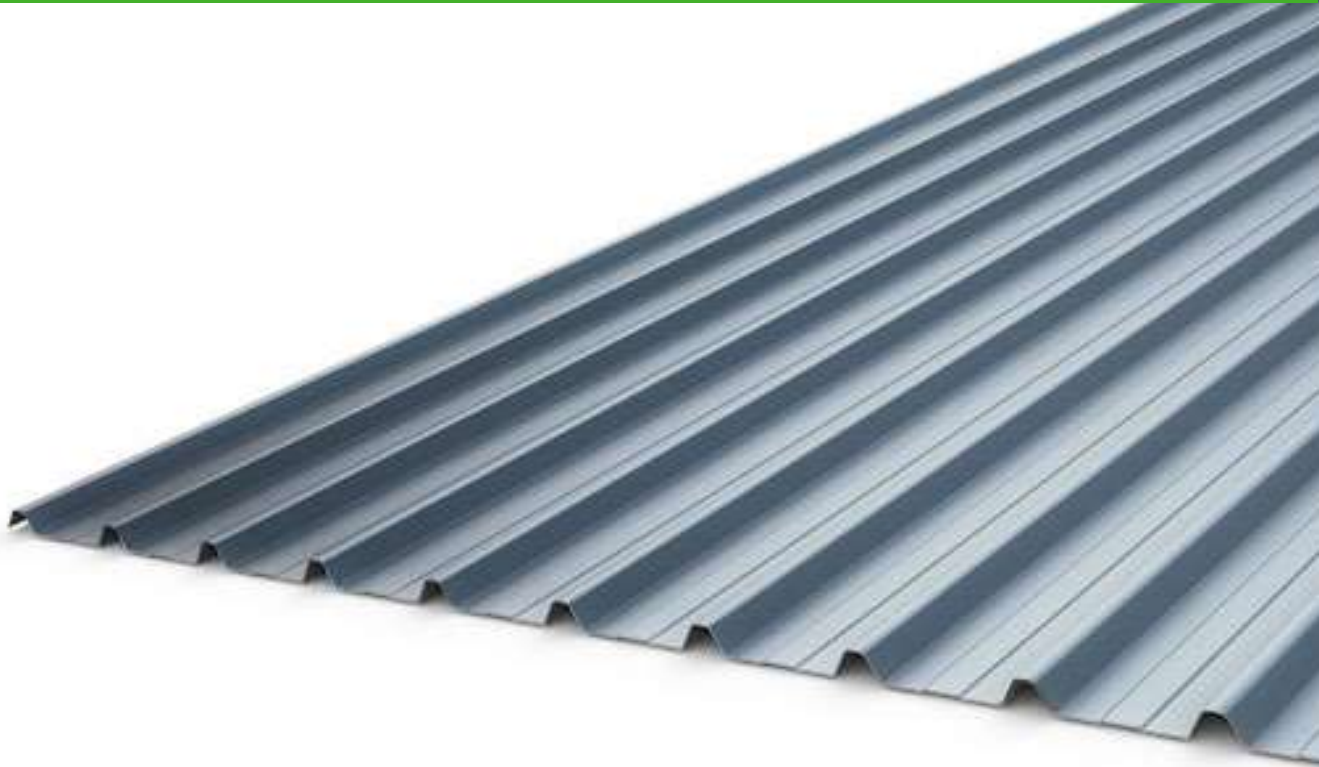

**hometech**<sup>™</sup>  
Better spaces. Better lives.

# Roofing Profile Guide



Updated December 2019



<i>Pressed Metal Tile</i> .....	A1
254G.....	A2
254G/2 .....	A3
404G.....	A4
254MD .....	A5
254MD/2.....	A6
404MD .....	A7
606MD .....	A8
254MDO.....	A9
404MDO.....	A10
254MDO/2 .....	A11
404MDO/2 .....	A12
254DIM .....	A13
404DIM .....	A14
254SEN.....	A15
404SEN.....	A16
254RS .....	A17
404RS .....	A18
254MEG .....	A19
404MEG .....	A20
254CH .....	A21
404CH .....	A22
254MET.....	A23
404MET.....	A24
254MR.....	A25
404MR.....	A26
254ANT .....	A27
404ANT .....	A28
254CS OLD 320mm .....	A29
404CS OLD 320mm .....	A30
254CS NEW 370mm .....	A31
404CS NEW 370mm .....	A32
254CS/380 NEW 380mm .....	A33
254OB .....	A34
404OB .....	A35
254MOD .....	A36

*Concrete/Terracotta Tile* ..... B1

254C.....	B2
254TC.....	B3
FL-290DS/T.....	B4
404C.....	B5
254FLX.....	B6
FL-230870.....	B7

*Long Run* ..... C1

254TAY.....	C2
404TAY.....	C3
254150.....	C4
404150.....	C5
254LT7.....	C6
404LT7.....	C7
254V.....	C8
404V.....	C9
254BB.....	C10
404BB.....	C11
606BB.....	C12
254225.....	C13
404225.....	C14
606225.....	C15
254SL.....	C16
254DD.....	C17
404DD.....	C18
254147.....	C19
404147.....	C20
606147.....	C21
254PD.....	C22
404PD.....	C23
254160.....	C24
404160.....	C25
606160.....	C26
254182.....	C27

404182 .....	C28
606182 .....	C29
254MT .....	C30
FL-290DS/MT .....	C31
<del>404MT</del> (Obsolete) .....	C32
404MT/F .....	C33
606MT .....	C34
254KL15 .....	C35
404KL15 .....	C36
254MK .....	C37
404MK .....	C38
404KL23 .....	C39
254LUX .....	C40
404LUX .....	C41
254125 .....	C42
254191 .....	C43
404191 .....	C44
606191 .....	C45
404192 .....	C46
254233 .....	C47
254178 .....	C48
404178 .....	C49
254WIN .....	C50
404WIN .....	C51
254TL .....	C52
404TL .....	C53
404235 .....	C54
254MC .....	C55
FL-290DS/MC .....	C56
404MC .....	C57
606MC .....	C58
254TO .....	C59
404TO .....	C60
254ST7 .....	C61
254192 .....	C62

*Flat Roof Profile* ..... *D1*

254S90 ..... D2

FL-210030 ..... D3

404S90 ..... D4

606S90 ..... D5

254S ..... D6

*Butynol Membrane* ..... *E1*

254UAF ..... E2

FL-290DS/MUG ..... E3

404UAF ..... E4

606UAF ..... E5

*Flashing Add-ons* ..... *F1*

DSCOLLAR – 290DS Adapter Ring ..... F2

25TR - Extender Turret Ring ..... F3

A

Pressed Metal Tile

# 254G

## Pressed Metal Tile

### ROOFING PROFILE

**Product:** Gerard Tuffcoat

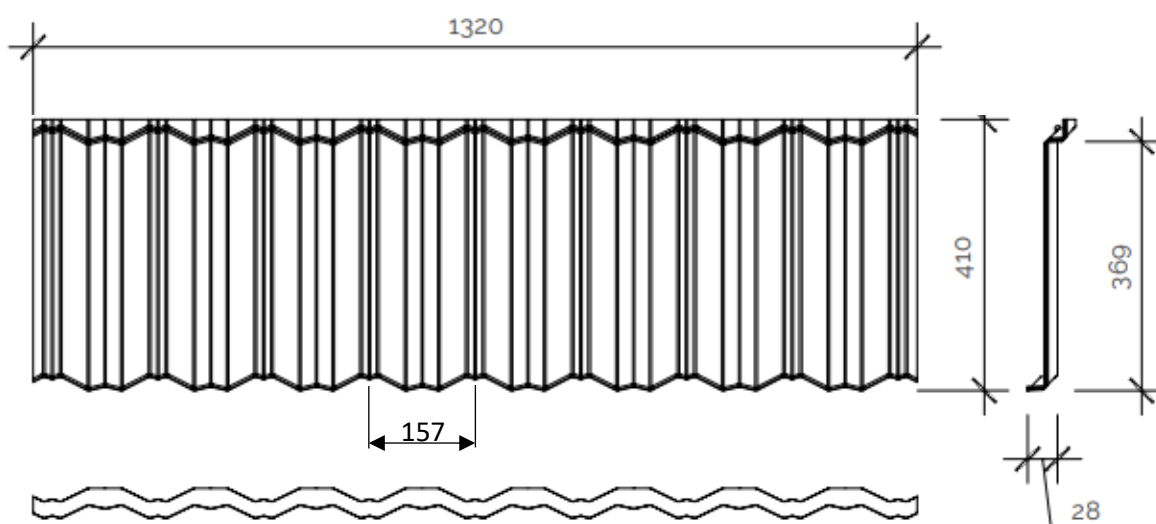
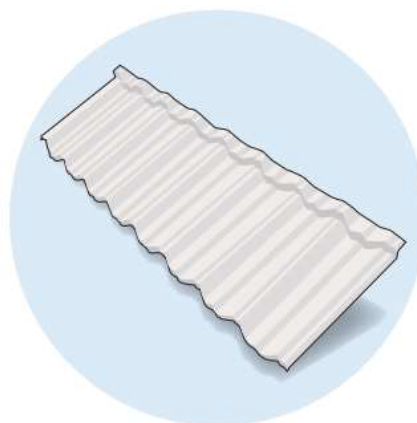
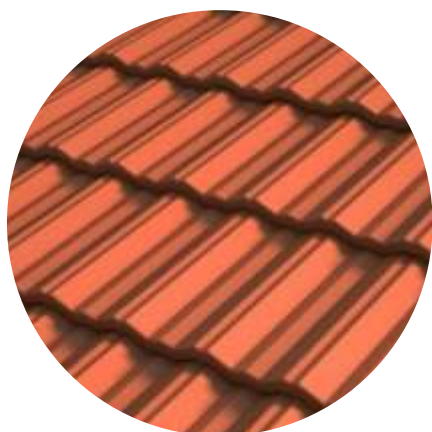

### FLASHING

**Homotech code:** 254G

**Hole diameter:** Ø250  
(Suitable for 160DS Solatube,  
ED100/150/200 Duct adapter)





# 254G/2

Pressed Metal Tile

## ROOFING PROFILE

**Product:** Gerard Tuffcoat

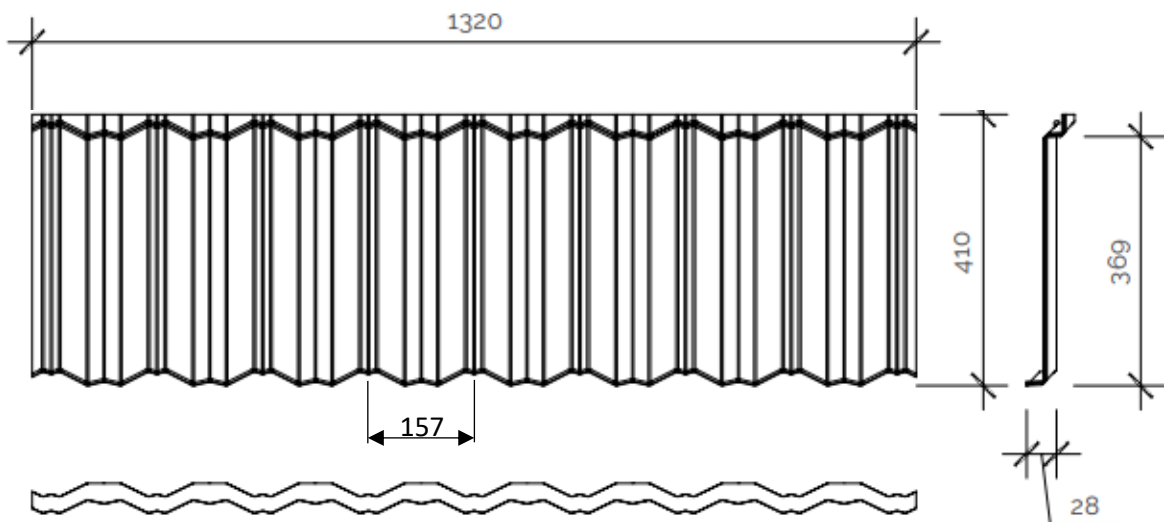
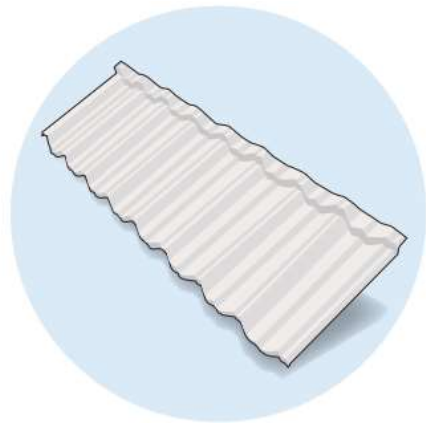
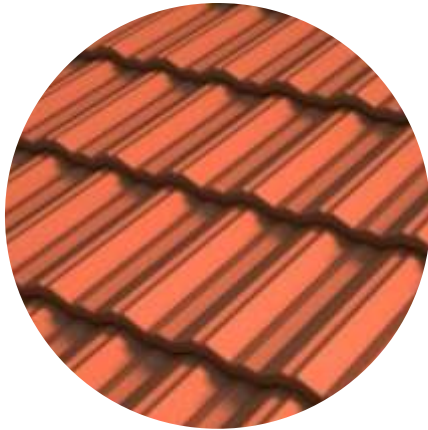

## FLASHING

**Homotech code:** 254G/2

**\*Extended  
turret**

**Hole diameter:**  $\varnothing 250$   
(Suitable for 160DS Solatube,  
ED100/150/200 Duct adapter)



# 404G

## Pressed Metal Tile

### ROOFING PROFILE

**Product:** Gerard Tuffcoat

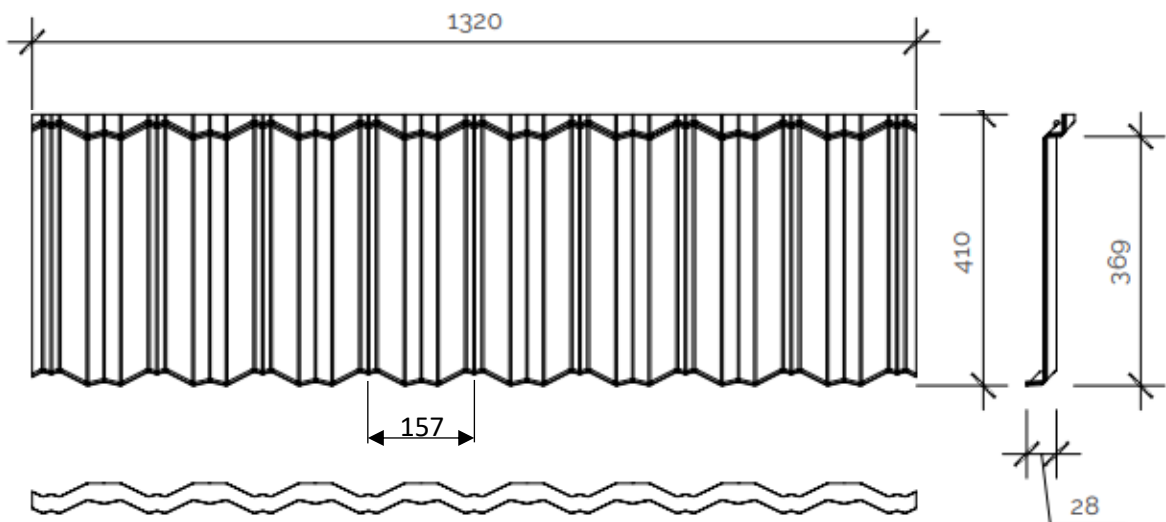
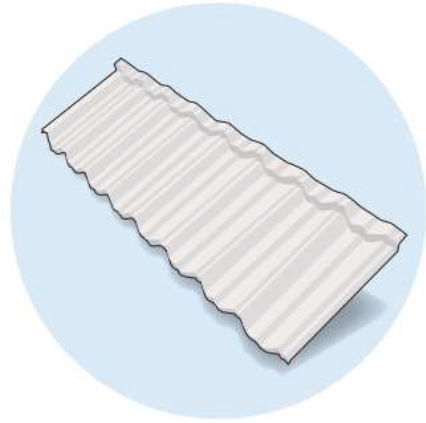
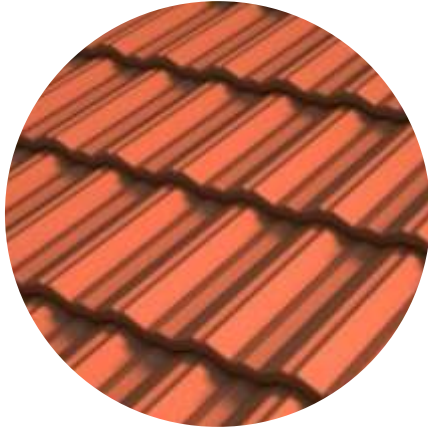

### FLASHING

**Homotech code:** 404G

**Hole diameter:** Ø400  
(Suitable for 290DS Solatube,  
requires DSCOLLAR,  
suitable for Solar Star RM1600)



# 254MD

Pressed Metal Tile

## ROOFING PROFILE

Product: Gerard Colortile (Decro)

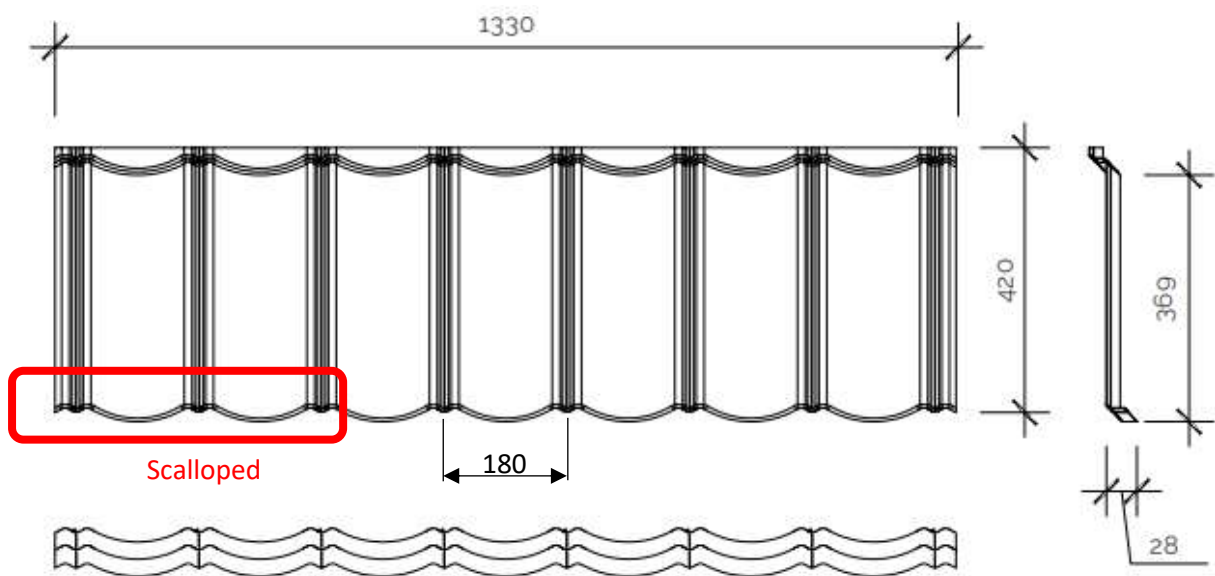
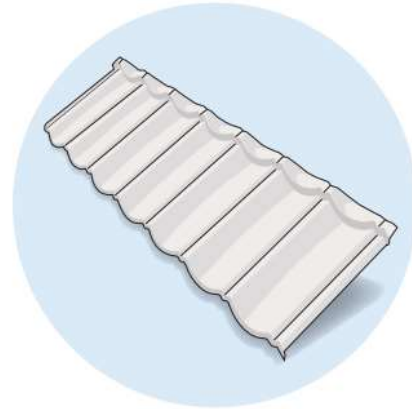
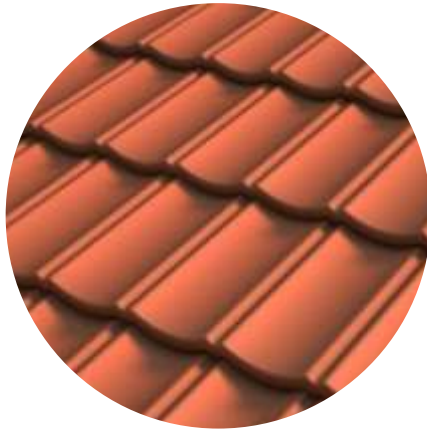

## FLASHING

Homotech code: 254MD

**Hole diameter:**  $\varnothing 250$   
(Suitable for 160DS Solatube,  
ED100/150/200 Duct reducer)



# 254MD/2

Pressed Metal Tile

## ROOFING PROFILE

**Product:** Gerard Colortile (Decro)

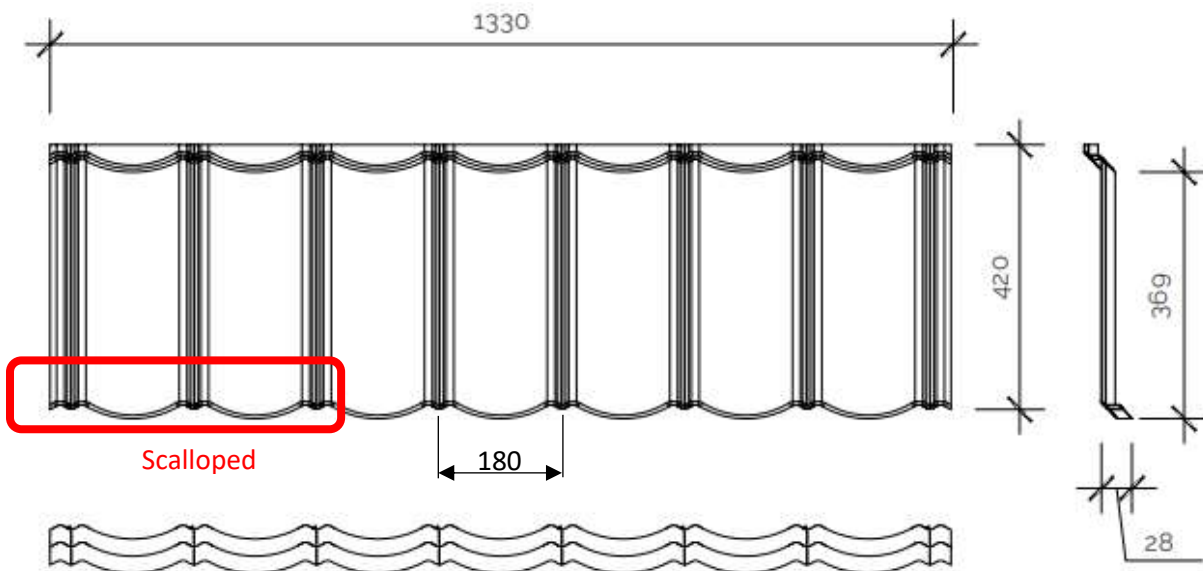
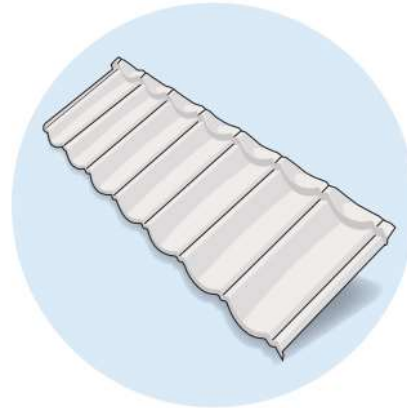
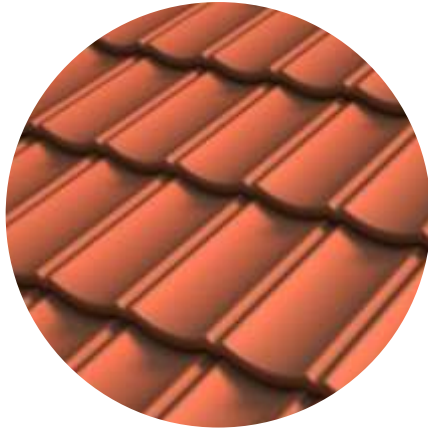

## FLASHING

**Hometech code:** 254MD/2

**Hole diameter:**  $\varnothing 250$   
(Suitable for 160DS Solatube,  
ED100/150/200 Duct reducer)



All dimensions in millimetres

# 404MD

Pressed Metal Tile

## ROOFING PROFILE

**Product:** Gerard Colortile (Decro)

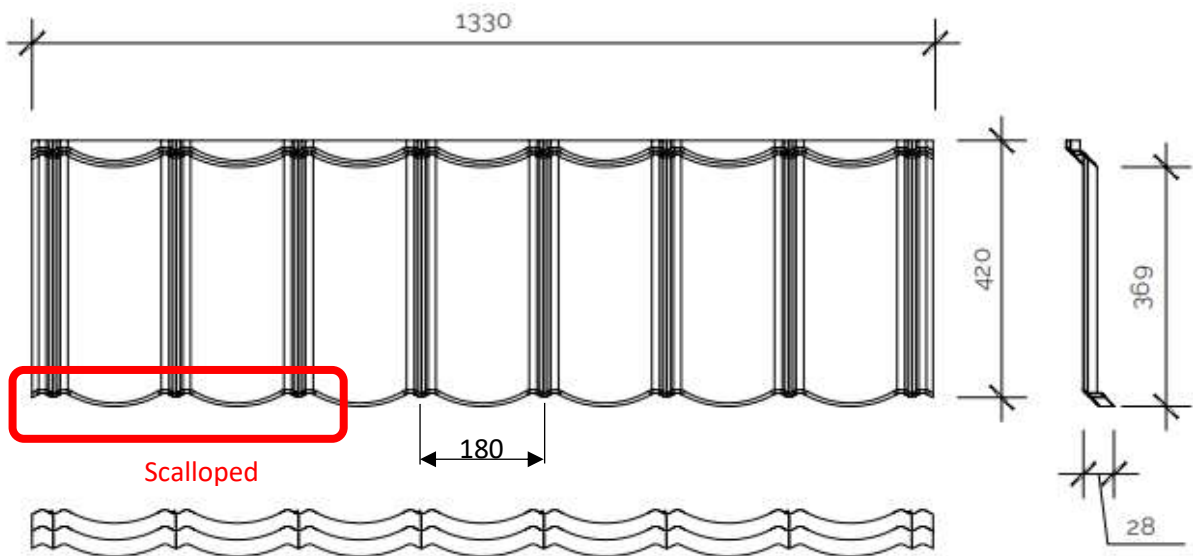
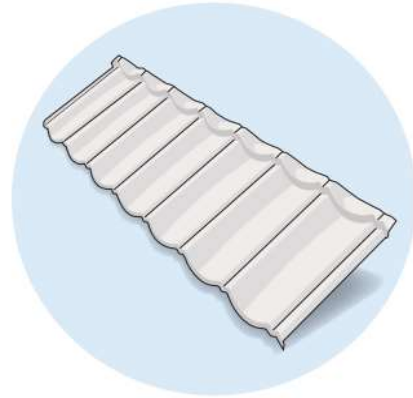
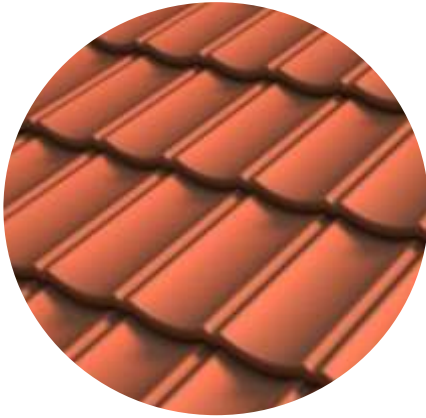

## FLASHING

**Hometech code:** 404MD

**Hole diameter:**  $\varnothing 400$   
(Suitable for 290DS Solatube,  
requires DSCOLLAR,  
suitable for Solar Star RM1600)



All dimensions in millimetres



# 606MD

Pressed Metal Tile

## ROOFING PROFILE

**Product:** Gerard Colortile (Decro)

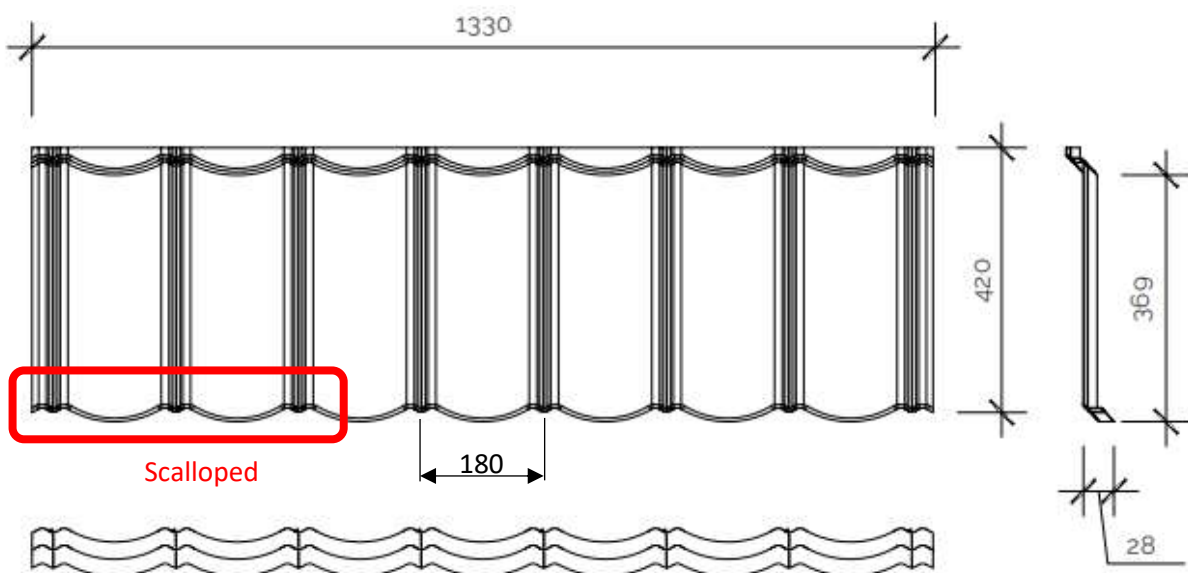
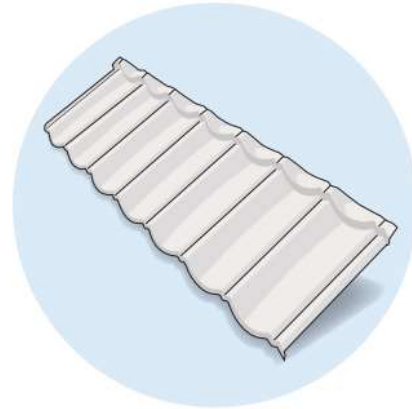
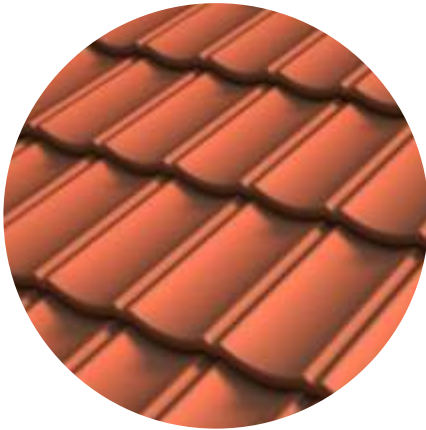

## FLASHING

**Homotech code:** 606MD

**Hole diameter:** Ø600  
(Suitable for 330DS, 750DS Solatube)



# 254MDO

Pressed Metal Tile

## ROOFING PROFILE

**Product:** Gerard Colortile (Decro)

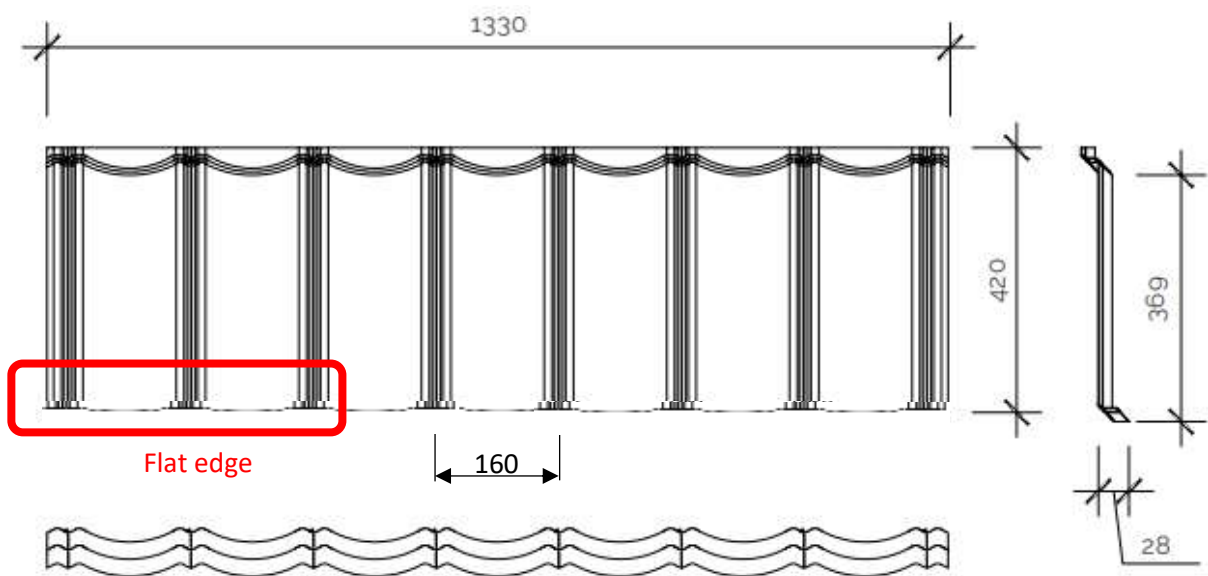
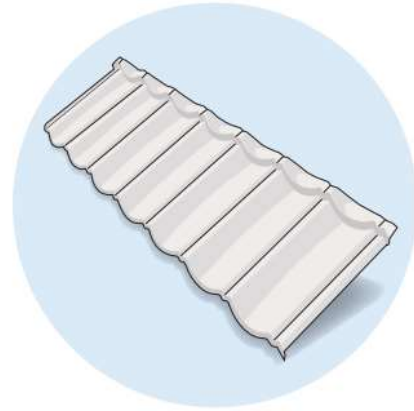
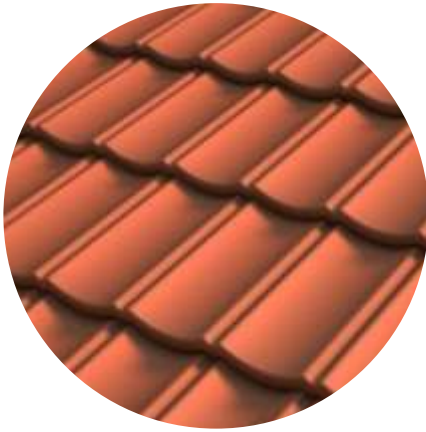

## FLASHING

**Homotech code:** 254MDO

**Hole diameter:**  $\varnothing 250$   
(Suitable for 160DS Solatube,  
ED100/150/200 Duct reducer)



# 404MDO

Pressed Metal Tile

## ROOFING PROFILE

**Product:** Gerard Colortile (Decro)

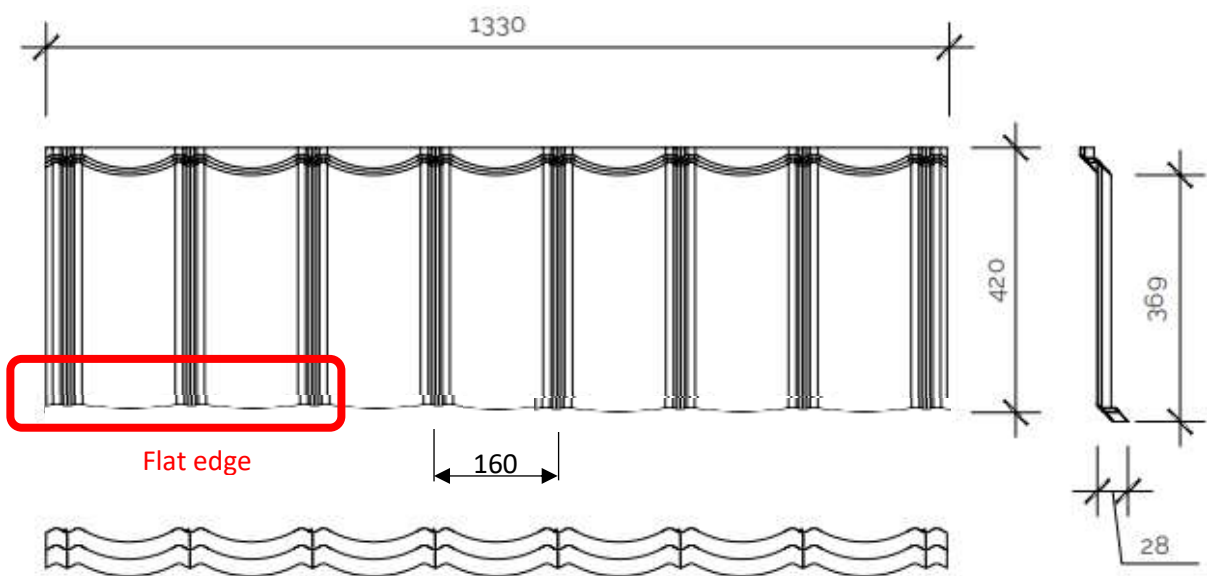
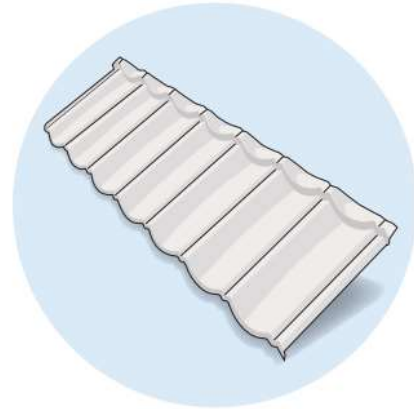
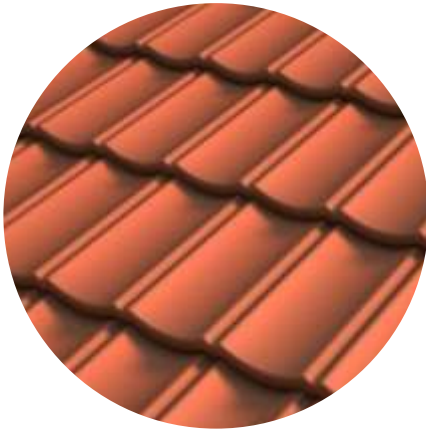

## FLASHING

**Homotech code:** 404MDO

**Hole diameter:** Ø400  
(Suitable for 290DS Solatube, requires DSCOLLAR, suitable for Solar Star RM1600)





# 254MDO/2

Pressed Metal Tile

## ROOFING PROFILE

**Product:** Residential Roofing (Christchurch) Azko

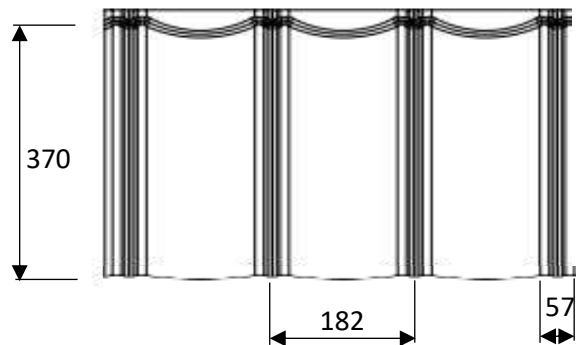
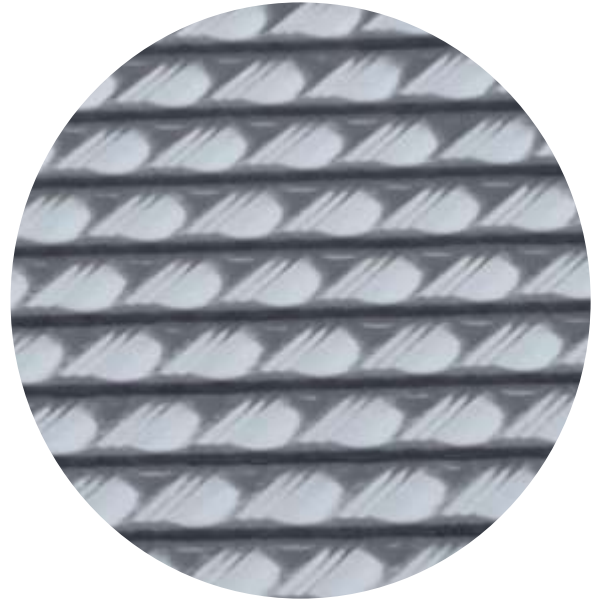

## FLASHING

**Homotech code:** 254MDO/2

**Hole diameter:** Ø250  
(Suitable for 160DS Solatube,  
ED100/150/200 Duct reducer)



# 404MDO/2

Pressed Metal Tile

## ROOFING PROFILE

**Product:** Residential Roofing (Christchurch) Azko

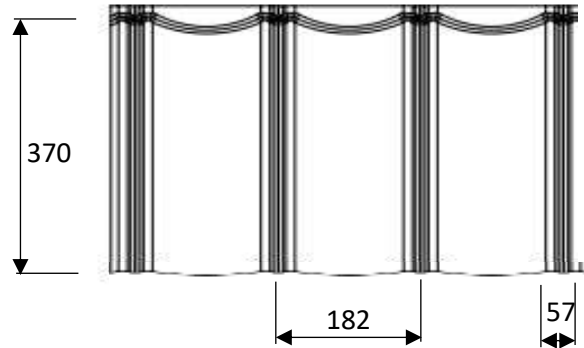
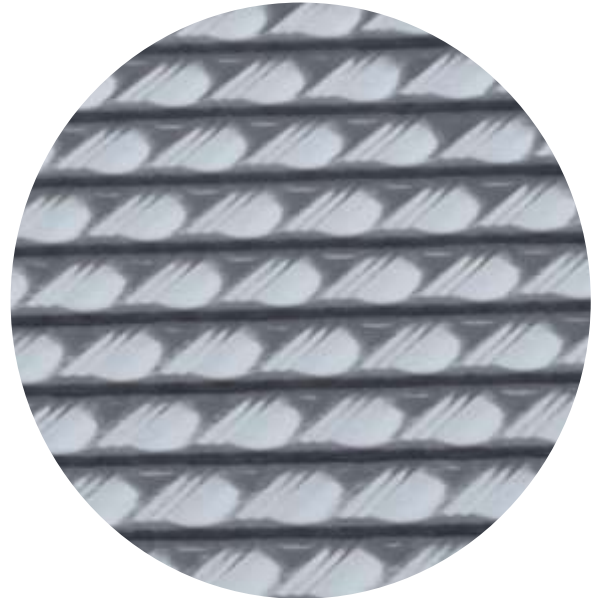

## FLASHING

**Homotech code:** 404MDO/2

**Hole diameter:** Ø400  
(Suitable for 290DS Solatube, requires DSCOLLAR, suitable for Solar Star RM1600)

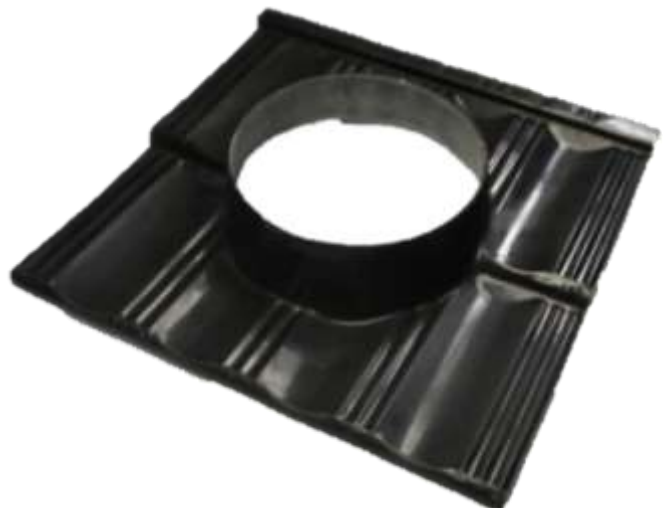

# 254DIM

Pressed Metal Tile

## ROOFING PROFILE

**Product:** Dimond Tile

---

## FLASHING

**Homotech code:** 254DIM

**Hole diameter:** Ø250  
(Suitable for 160DS Solatube,  
ED100/150/200 Duct reducer)



All dimensions in millimetres

# 404DIM

Pressed Metal Tile

## ROOFING PROFILE

**Product:** Dimond Tile

---

## FLASHING

**Homotech code:** 404DIM

**Hole diameter:**  $\varnothing 400$   
(Suitable for 290DS Solatube, requires  
DSCOLLAR,  
suitable for Solar Star RM1600)

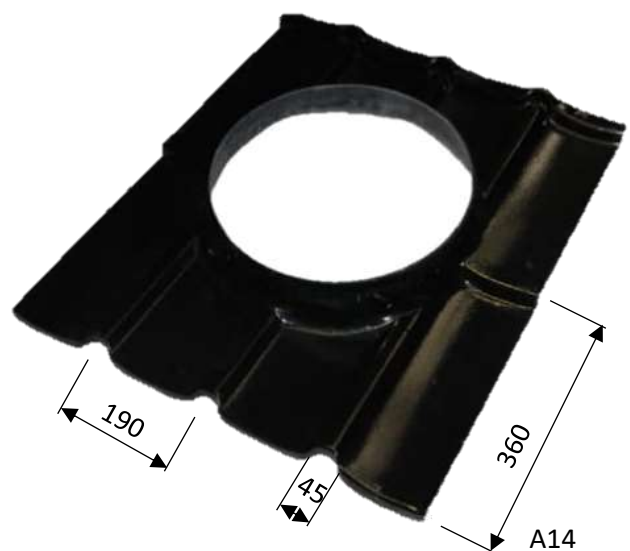

All dimensions in millimetres

# 254SEN

Pressed Metal Tile

## ROOFING PROFILE

**Product:** Gerard Senator

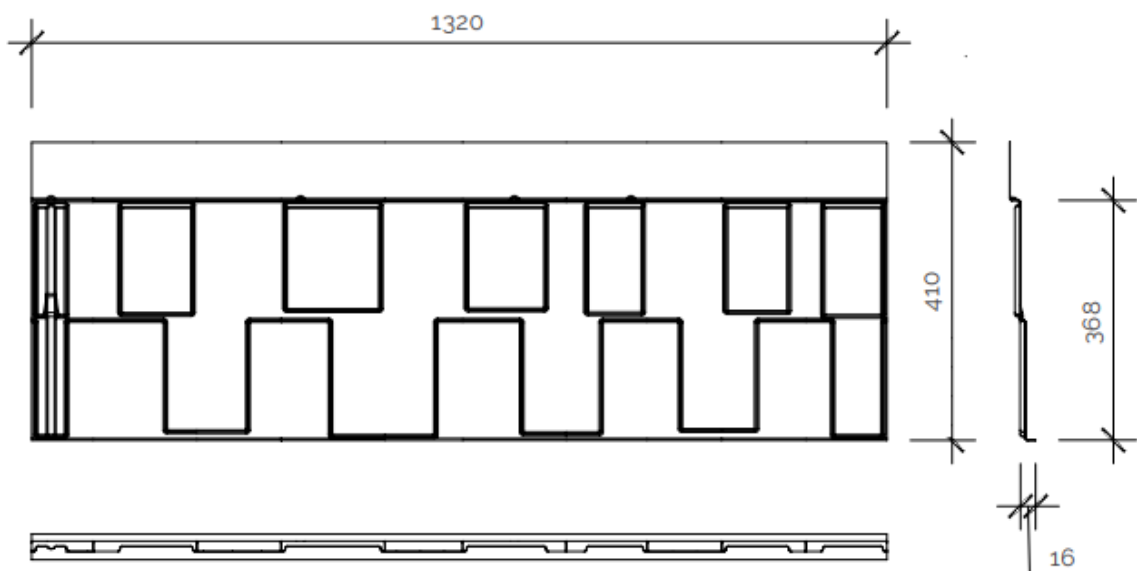
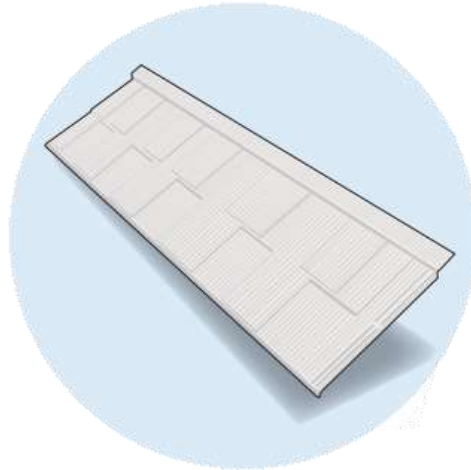

## FLASHING

**Hometech code:** 254SEN

**Hole diameter:**  $\varnothing 250$   
(Suitable for 160DS Solatube,  
ED100/150/200 Duct reducer)



# 404SEN

Pressed Metal Tile

## ROOFING PROFILE

Product: Gerard Senator

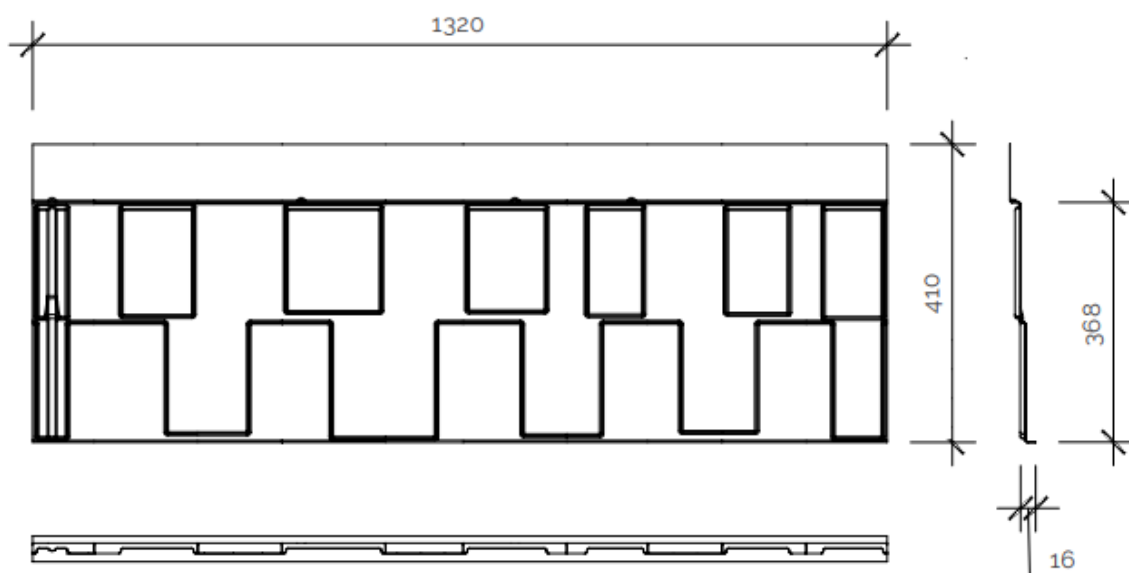
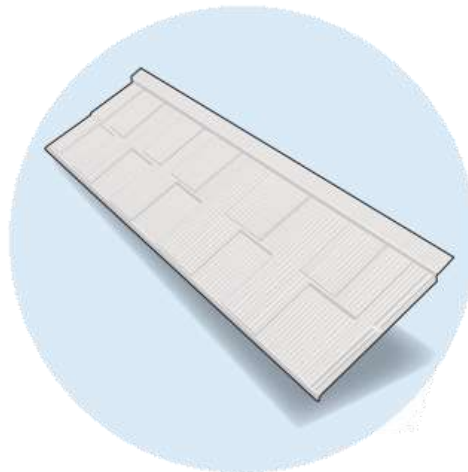

## FLASHING

Homotech code: 404SEN

**Hole diameter:  $\varnothing 400$**   
(Suitable for 290DS Solatube,  
requires DSCOLLAR,  
suitable for Solar Star RM1600)



# 254RS

Pressed Metal Tile

## ROOFING PROFILE

Product: Metrotile CF Slate

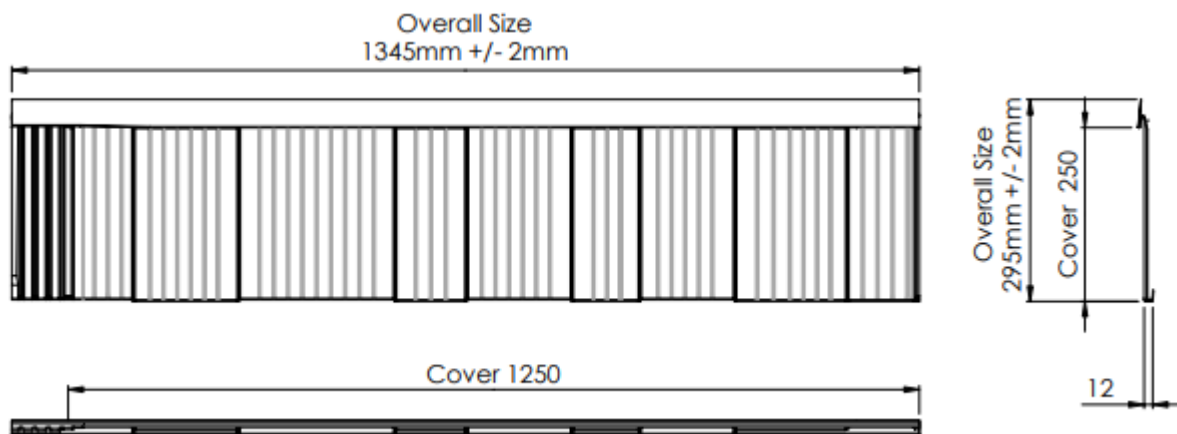
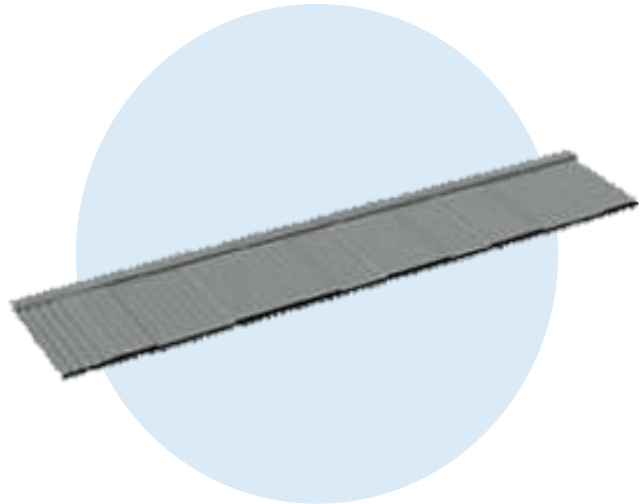

## FLASHING

Homotech code: 254RS

Hole diameter:  $\varnothing 250$   
(Suitable for 160DS Solatube,  
ED100/150/200 Duct reducer)

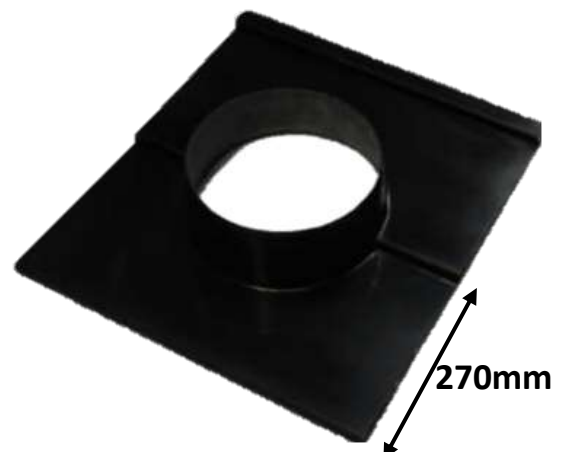

A17

# 404RS

Pressed Metal Tile

## ROOFING PROFILE

Product: Metrotile CF Slate

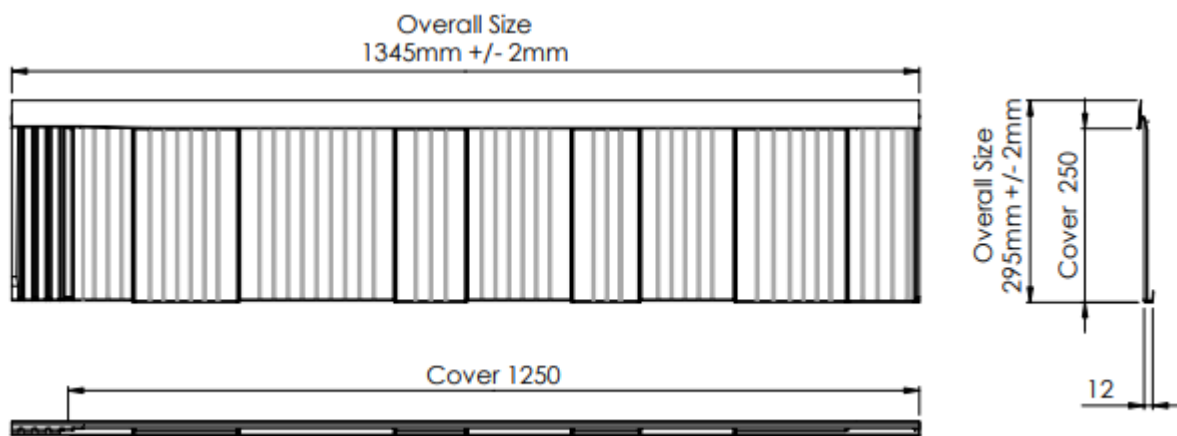
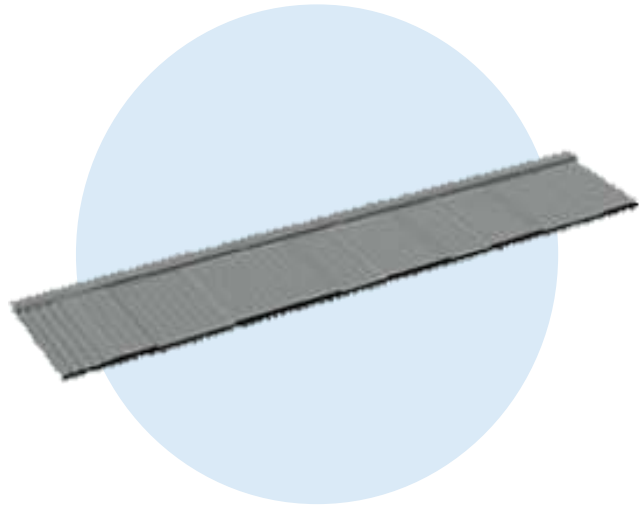

## FLASHING

Homotech code: 404RS

Hole diameter:  $\varnothing 400$   
(Suitable for 290DS Solatube, requires DSCOLLAR, suitable for Solar Star RM1600)

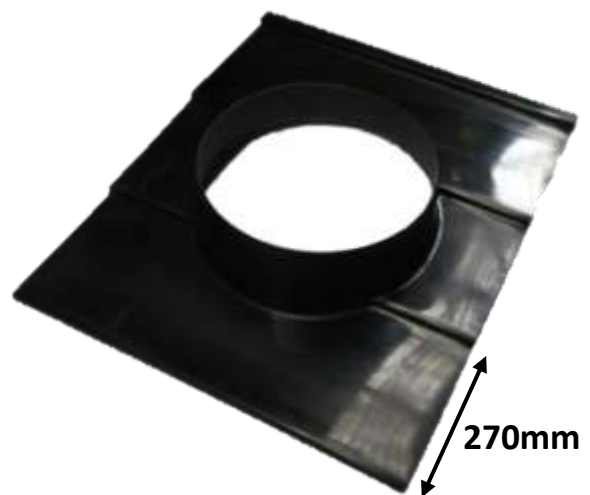

A18



# 254MEG

Pressed Metal Tile

## ROOFING PROFILE

Product: Megami

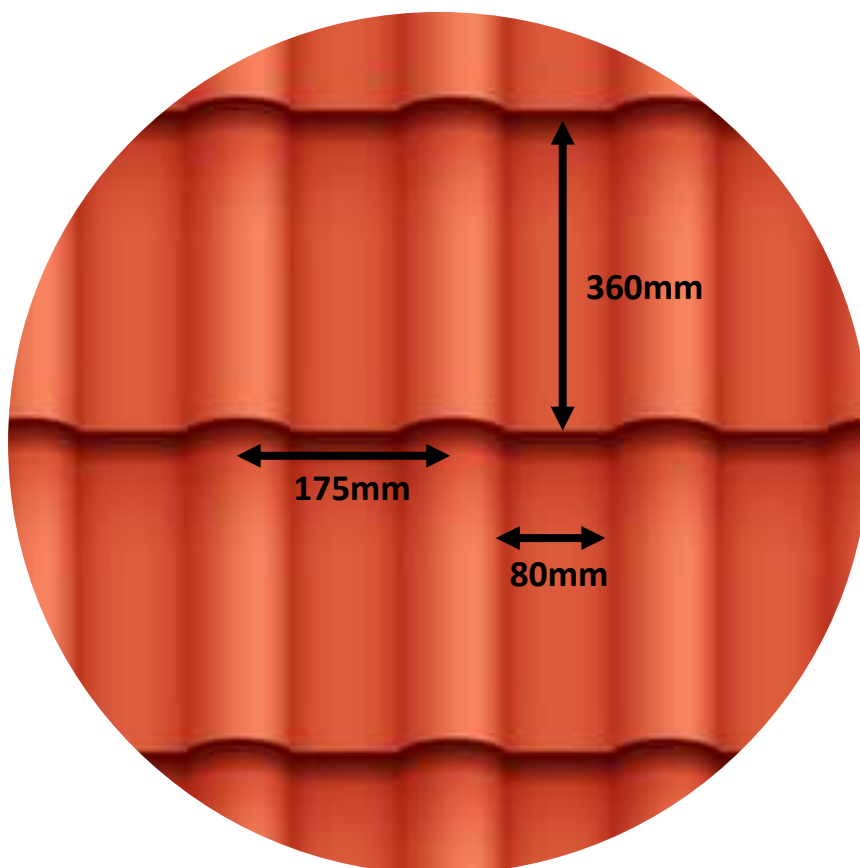

## FLASHING

Homotech code: 254MEG

Hole diameter:  $\varnothing 250$   
(Suitable for 160DS Solatube,  
ED100/150/200 Duct reducer)



# 404MEG

Pressed Metal Tile

## ROOFING PROFILE

Product: Megami

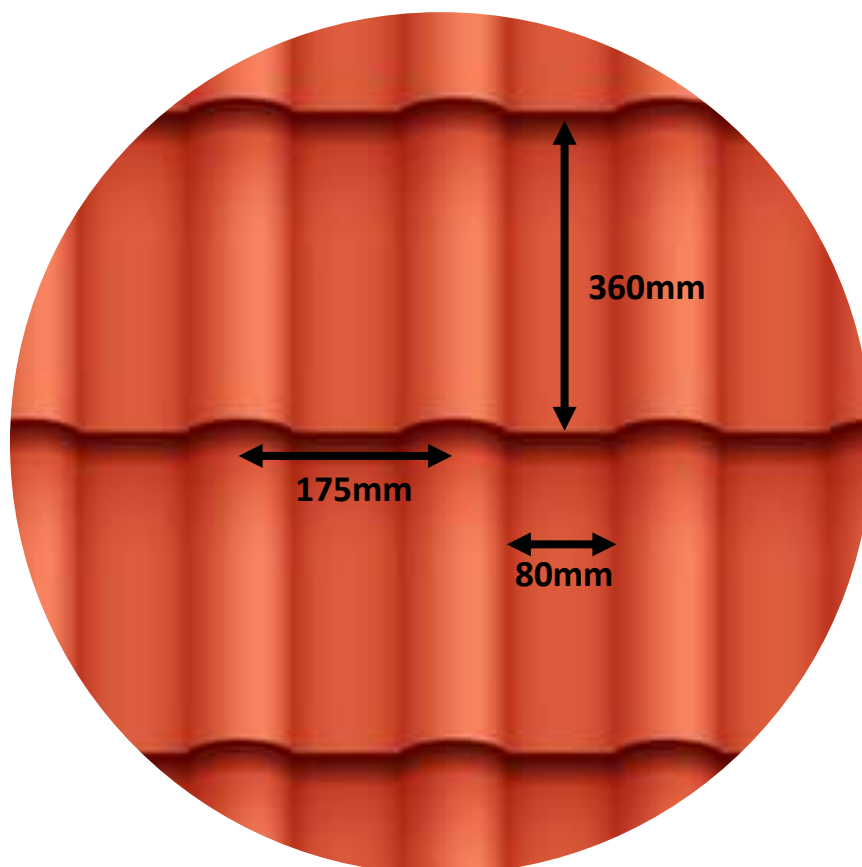

## FLASHING

Homotech code: 404MEG

**Hole diameter:  $\varnothing$ 400**  
(Suitable for 290DS Solatube,  
requires DSCOLLAR,  
suitable for Solar Star RM1600)



# 254CH

Pressed Metal Tile

## ROOFING PROFILE

**Product:** Metalcraft Chateau

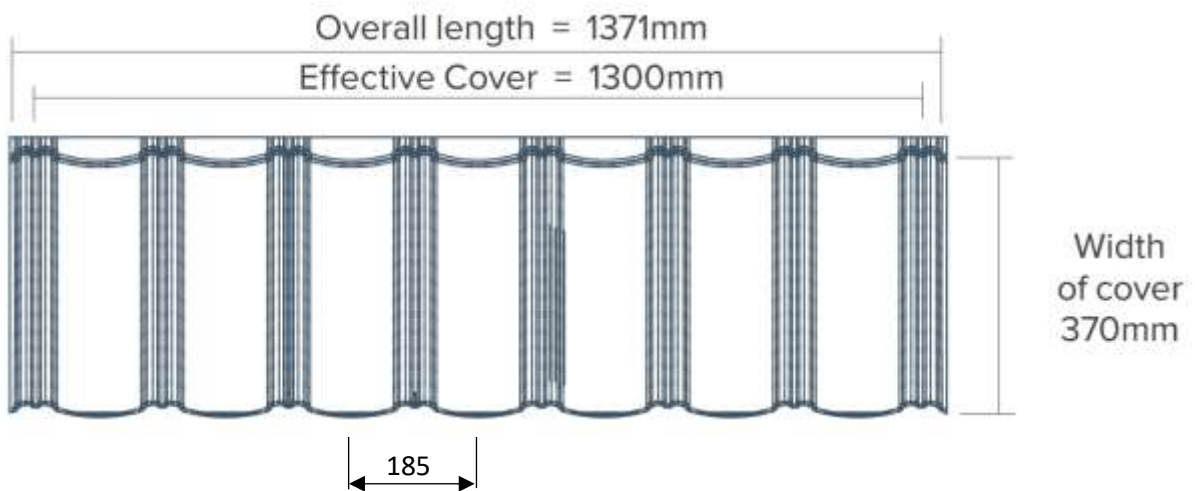
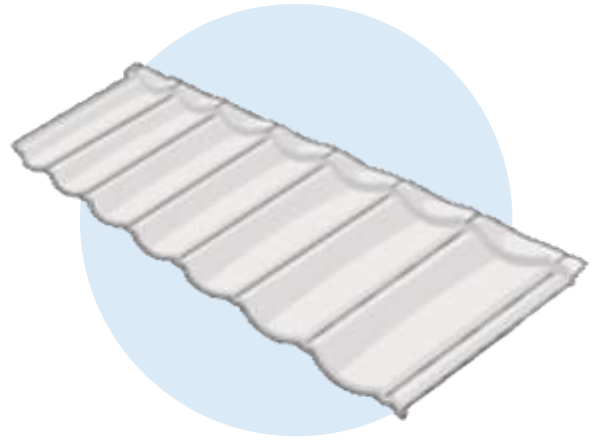
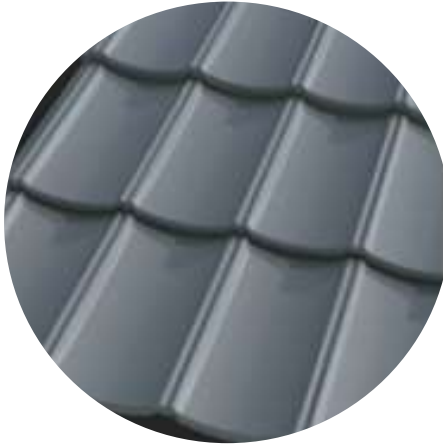

## FLASHING

**Homotech code:** 254CH

**Hole diameter:** Ø250  
(Suitable for 160DS Solatube,  
ED100/150/200 Duct reducer)



# 404CH

## Pressed Metal Tile

### ROOFING PROFILE

**Product:** Metalcraft Chateau

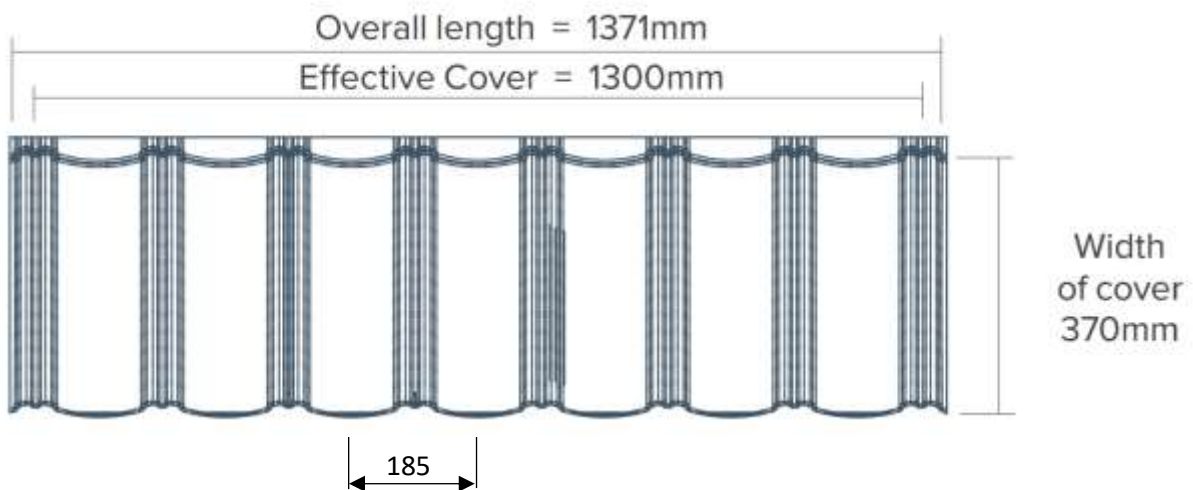
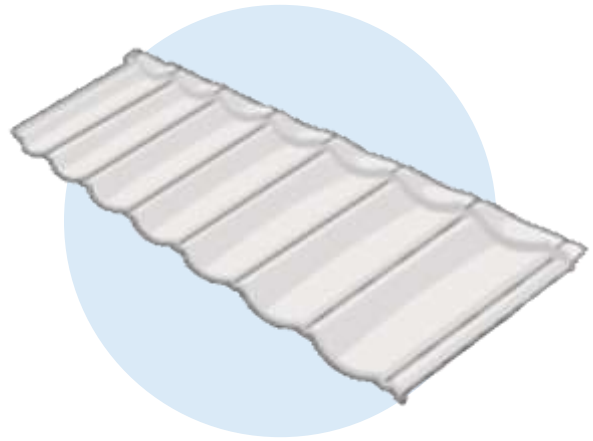

### FLASHING

**Homotech code:** 404CH

**Hole diameter:**  $\varnothing 400$   
(Suitable for 290DS Solatube,  
requires DSCOLLAR,  
suitable for Solar Star RM1600)

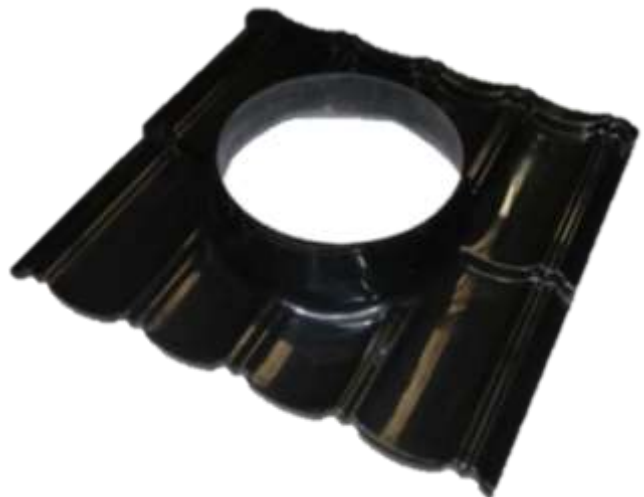

# 254MET

Pressed Metal Tile

## ROOFING PROFILE

**Product:** Metrotile Bond

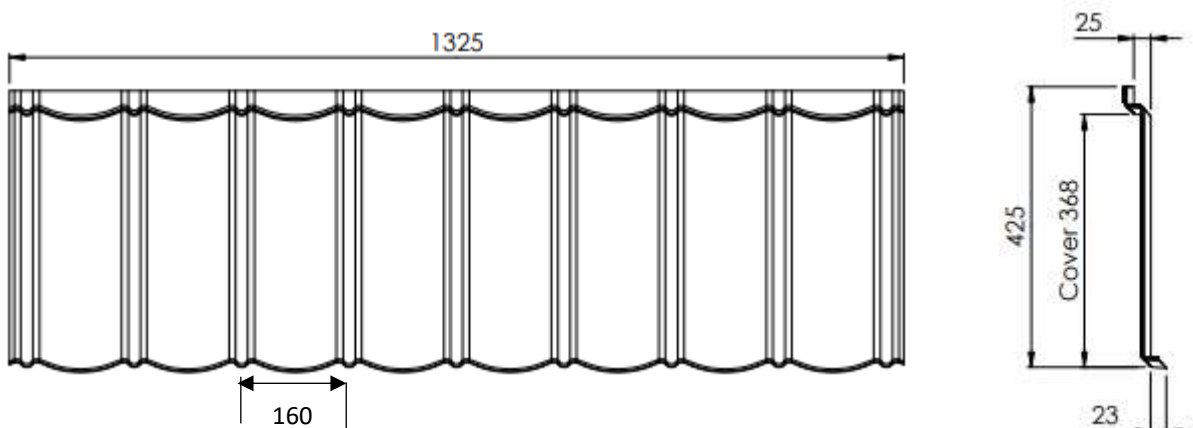
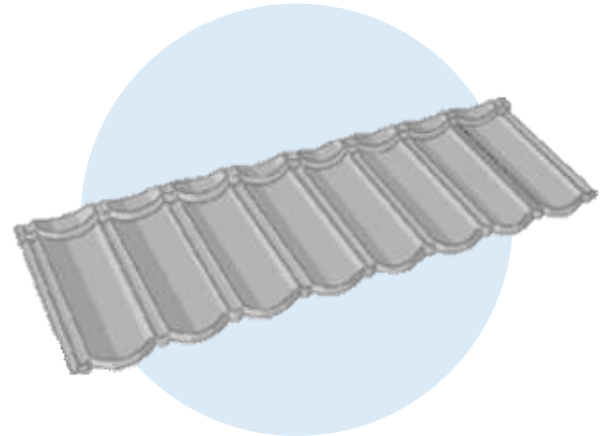

## FLASHING

**Homotech code:** 254MET

**Hole diameter:**  $\varnothing 250$   
(Suitable for 160DS Solatube,  
ED100/150/200 Duct reducer)

**\*Extended  
Turret**



All dimensions in millimetres (nominal)

# 404MET

Pressed Metal Tile

## ROOFING PROFILE

**Product:** Metrotile Bond

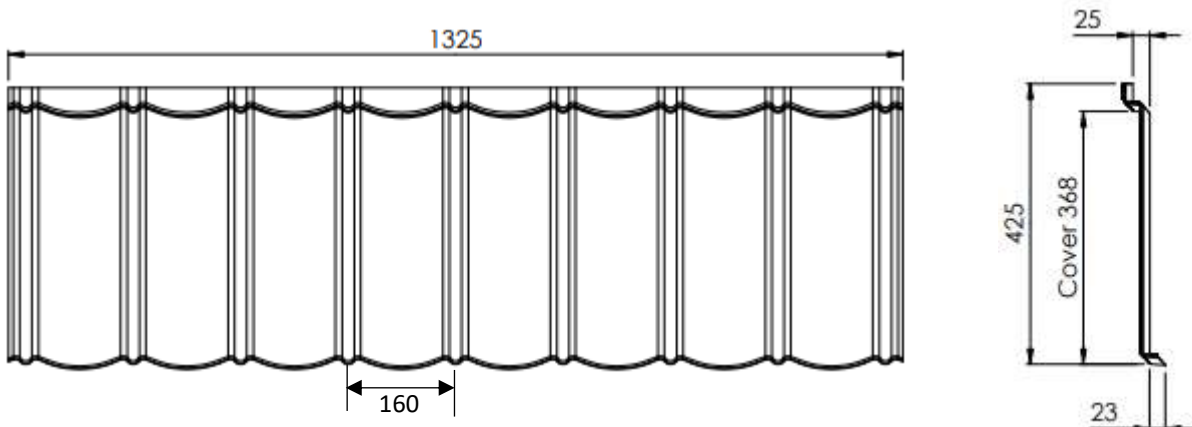
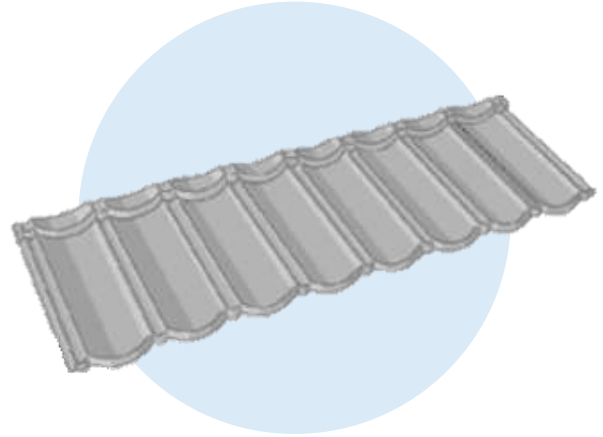

## FLASHING

**Homotech code:** 404MET

**Hole diameter:** Ø400  
(Suitable for 290DS Solatube, requires DSCOLLAR, suitable for Solar Star RM1600)



# 254MR

Pressed Metal Tile

## ROOFING PROFILE

Product: Metrotile Roman

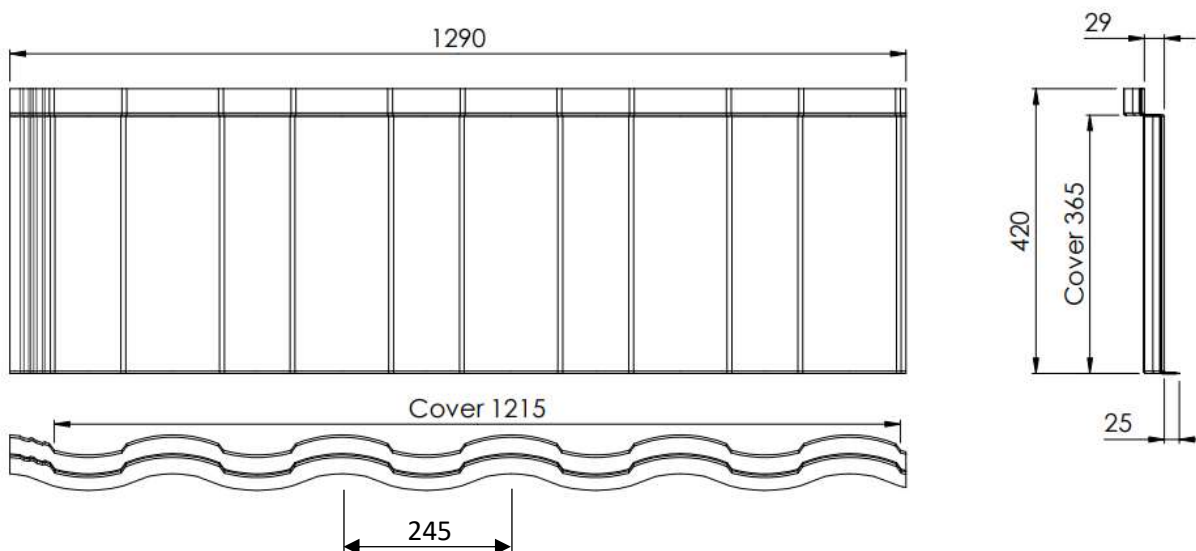
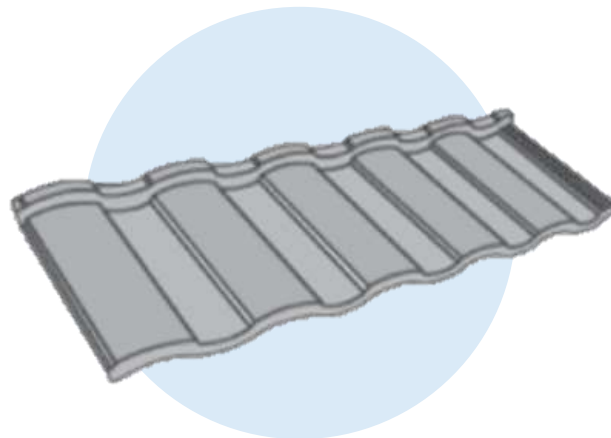

## FLASHING

Homotech code: 254MR

Hole diameter:  $\varnothing 250$   
(Suitable for 160DS Solatube,  
ED100/150/200 Duct reducer)



# 404MR

## Pressed Metal Tile

### ROOFING PROFILE

**Product:** Metrotile Roman

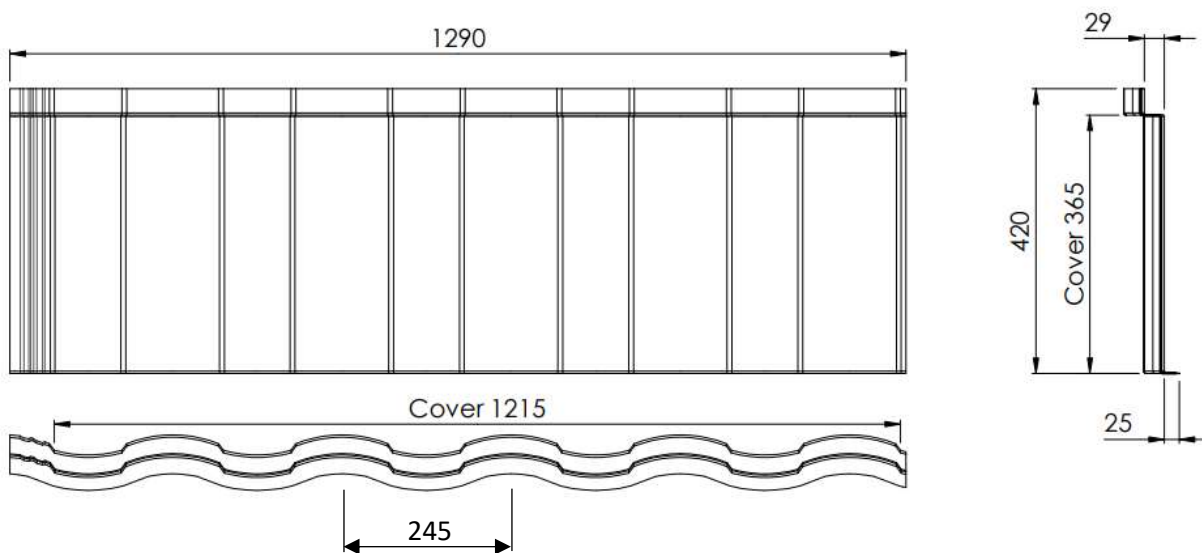
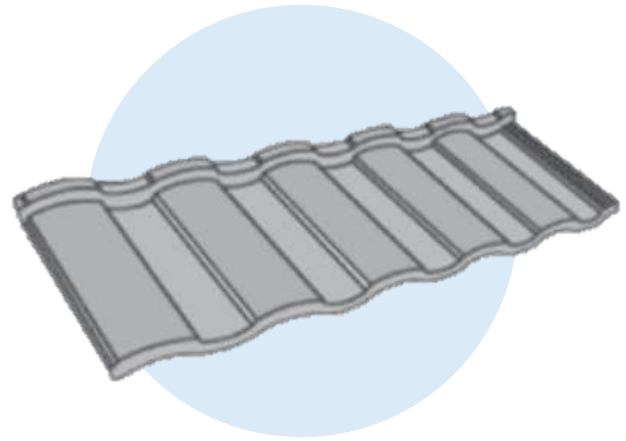

### FLASHING

**Homotech code:** 404MR

**Hole diameter:**  $\varnothing 400$   
(Suitable for 290DS Solatube,  
requires DSCOLLAR,  
suitable for Solar Star RM1600)





# 254ANT

Pressed Metal Tile

## ROOFING PROFILE

Product: Metrotile Antica

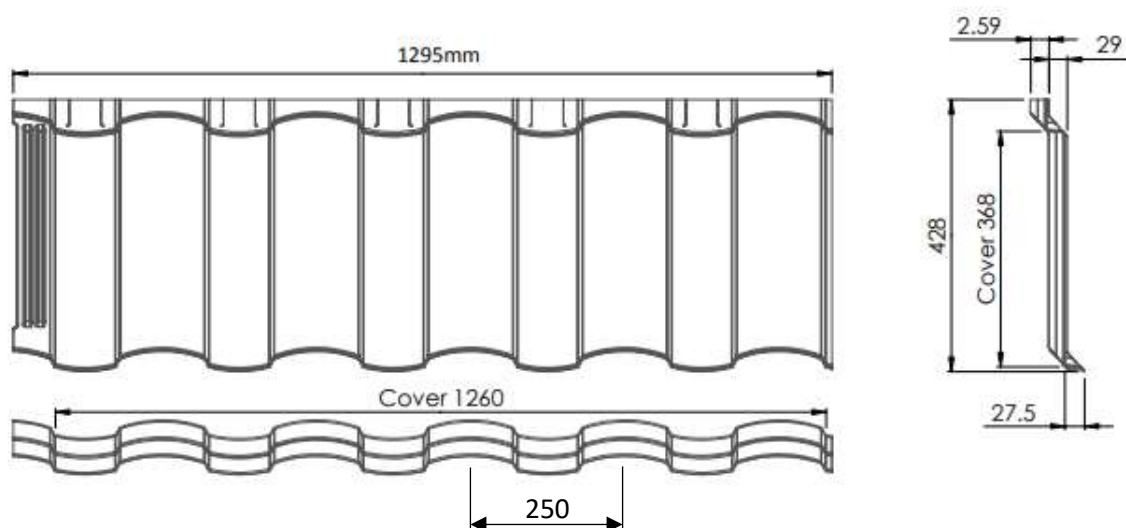
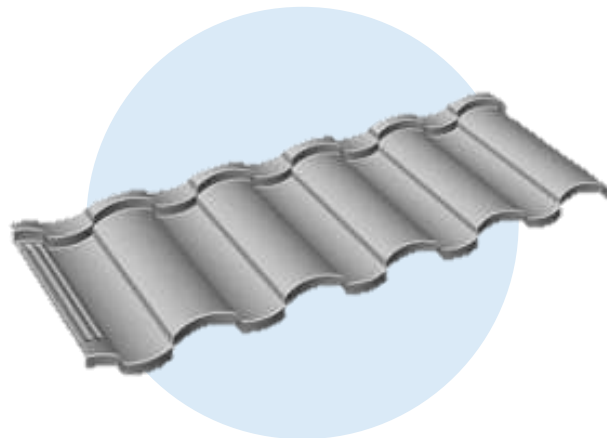
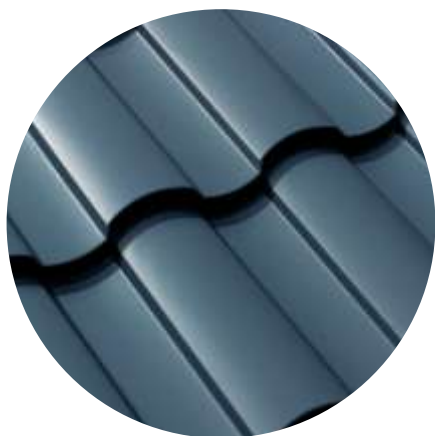

## FLASHING

Homotech code: 254ANT

Hole diameter:  $\varnothing 250$   
(Suitable for 160DS Solatube,  
ED100/150/200 Duct reducer)

Photo

# 404ANT

Pressed Metal Tile

## ROOFING PROFILE

Product: Metrotile Antica

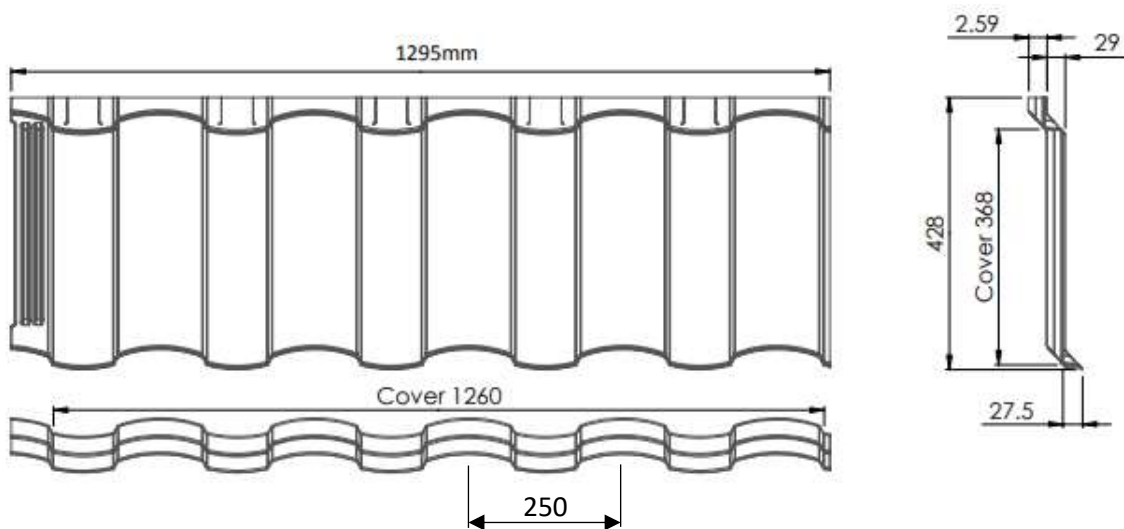
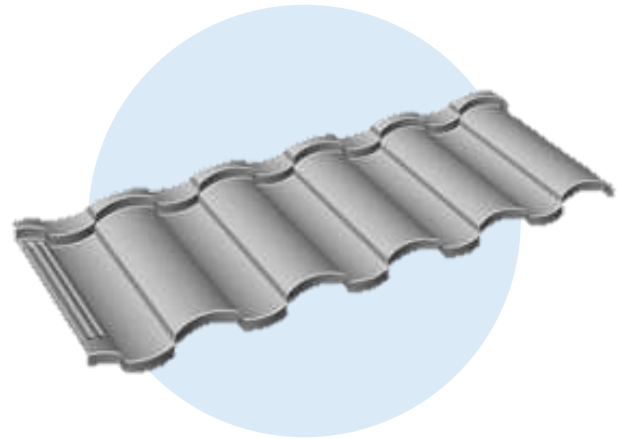
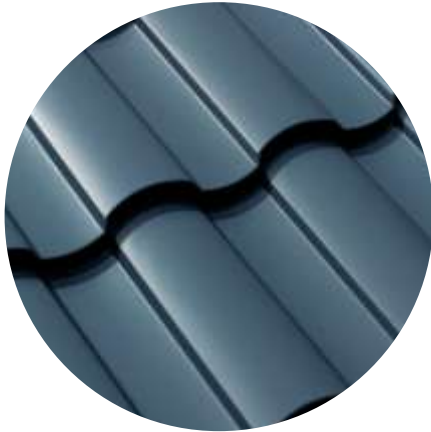

## FLASHING

Homotech code: 404ANT

**Hole diameter:  $\varnothing$ 400**  
(Suitable for 290DS Solatube,  
requires DSCOLLAR,  
suitable for Solar Star RM1600)



# 254CS OLD 320mm

Pressed Metal Tile

## ROOFING PROFILE

Product: Shake tile

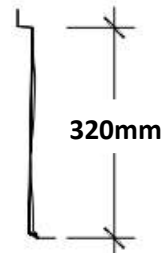
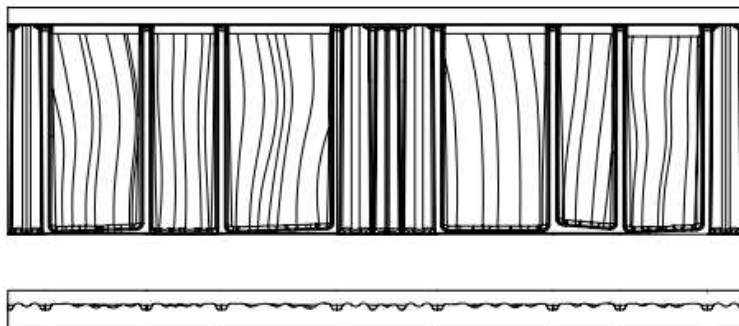
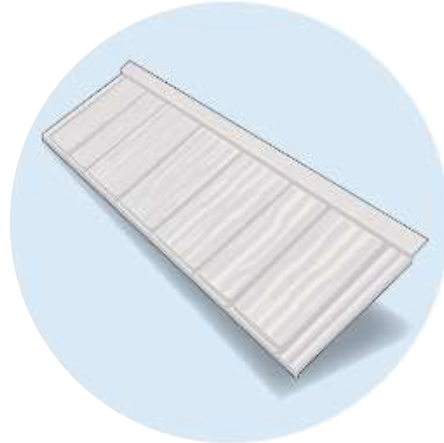
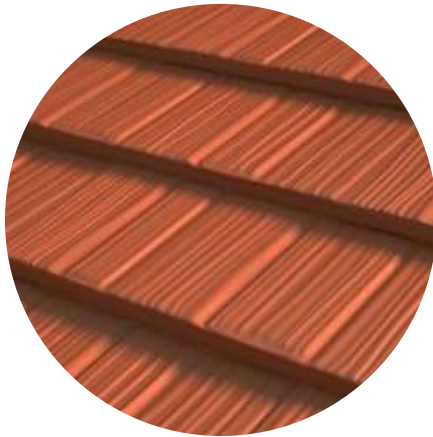

## FLASHING

Homotech code: 254CS OLD 320mm

**Hole diameter:**  $\varnothing 250$   
(Suitable for 160DS Solatube,  
ED100/150/200 Duct reducer)

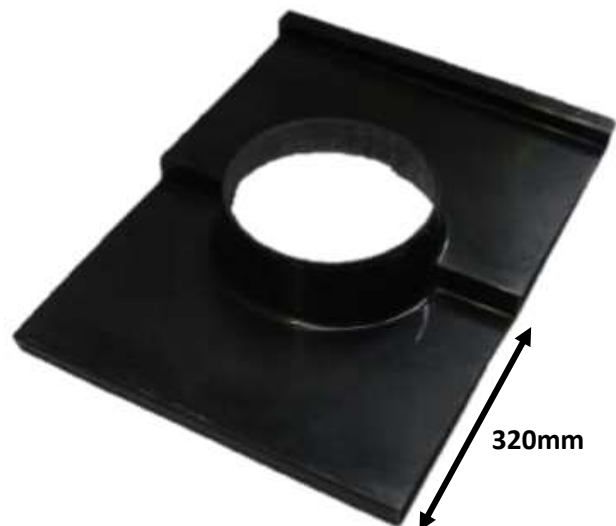

All dimensions in millimetres (nominal)

# 404CS OLD 320mm

Pressed Metal Tile

## ROOFING PROFILE

Product: Shake tile

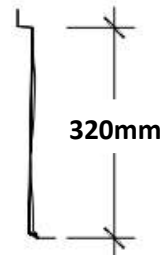
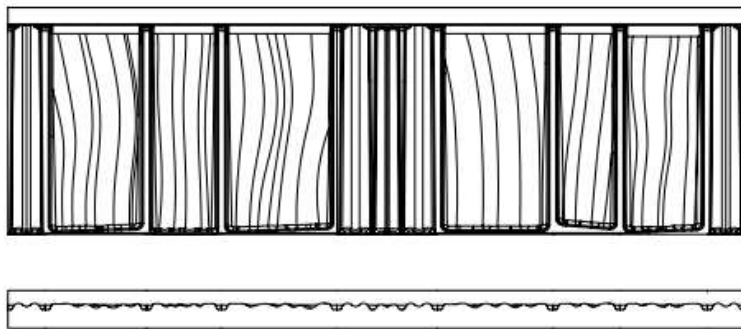
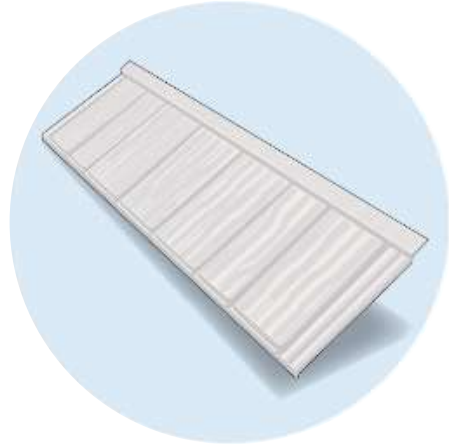
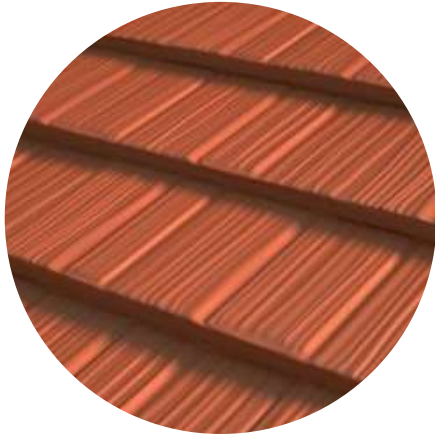

## FLASHING

Homotech code: 404CS OLD 320mm

Hole diameter  $\varnothing 400$   
(Suitable for 290DS Solatube,  
requires DSCOLLAR,  
suitable for Solar Star RM1600)



# 254CS NEW 370mm

Pressed Metal Tile

## ROOFING PROFILE

**Product:** Gerard Corona  
Metrotile Shake  
Metalcraft Shake Metal Tile

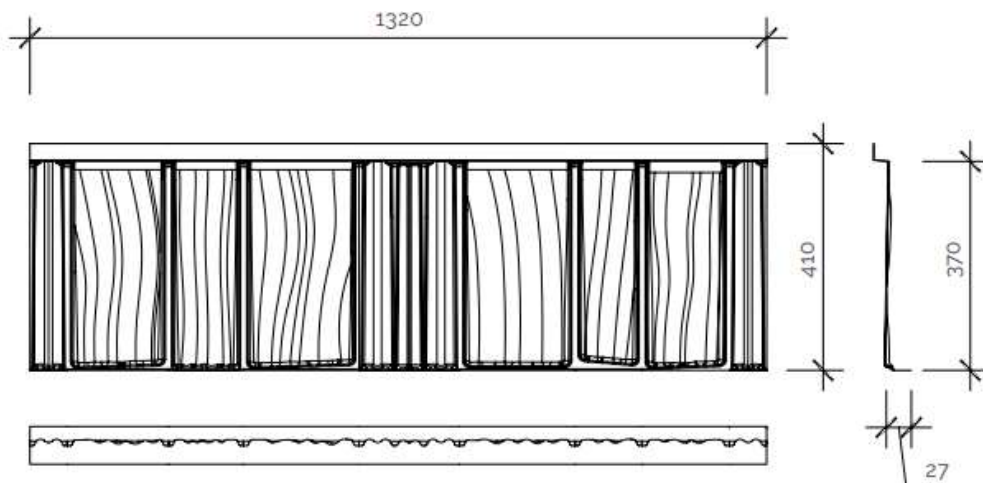
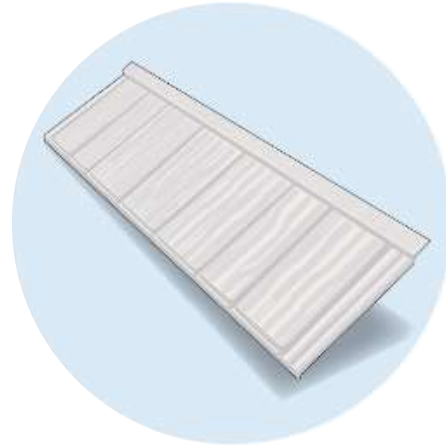
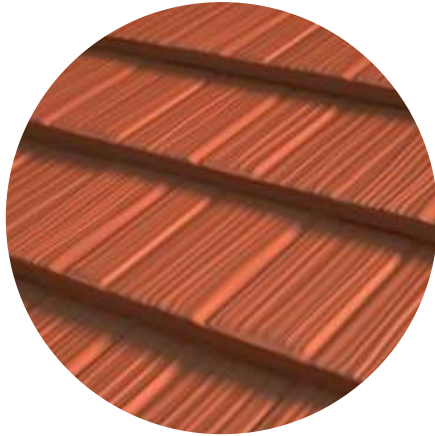

## FLASHING

**Homotech code:** 254CS NEW 370mm

**Hole diameter:**  $\varnothing 250$   
(Suitable for 160DS Solatube,  
ED100/150/200 Duct reducer)

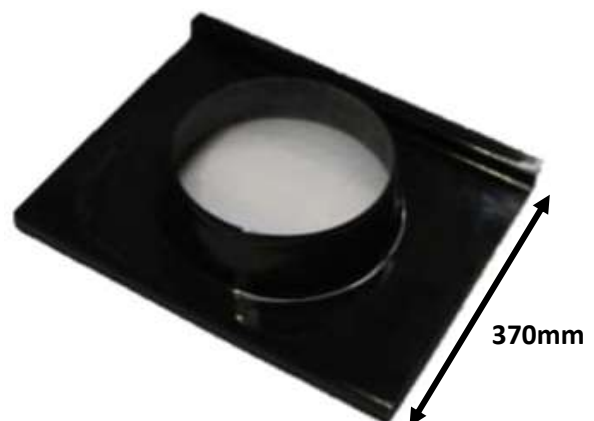

All dimensions in millimetres (nominal)

A31

# 404CS NEW 370mm

Pressed Metal Tile

## ROOFING PROFILE

**Product:** Gerard Corona  
Metrotile Shake  
Metalcraft Shake Metal Tile

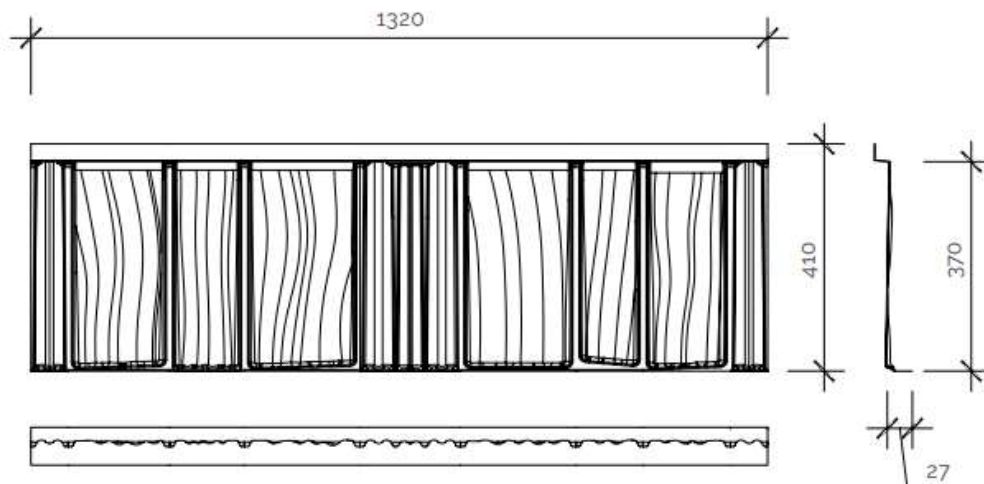
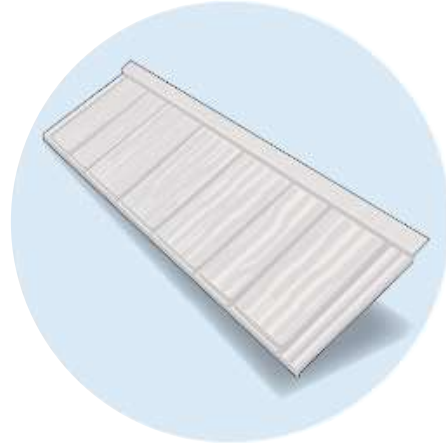
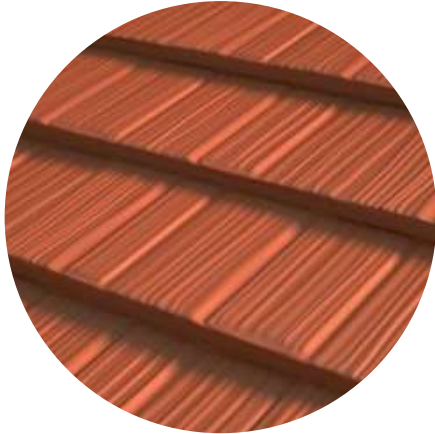

## FLASHING

**Homotech code:** 404CS NEW 370mm

**Hole diameter:**  $\varnothing 400$   
(Suitable for 290DS Solatube, requires DSCOLLAR, suitable for Solar Star RM1600)

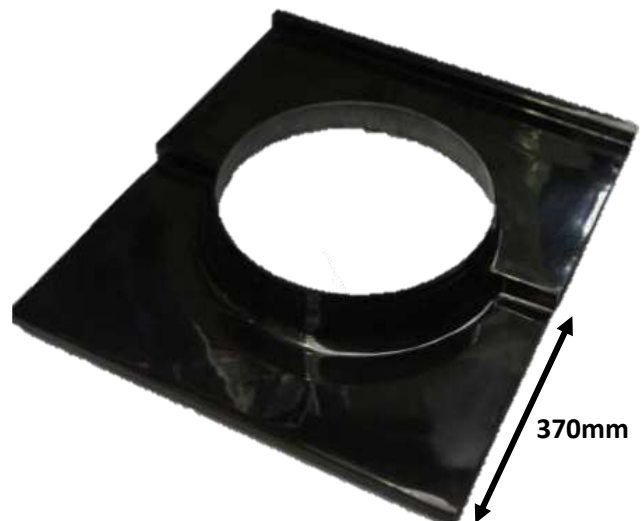

All dimensions in millimetres (nominal)

A32



# 254CS/380 NEW 380mm

Pressed Metal Tile

## ROOFING PROFILE

**Product:** Gerard Corona  
Metrotile Shake  
Metalcraft Shake Metal Tile

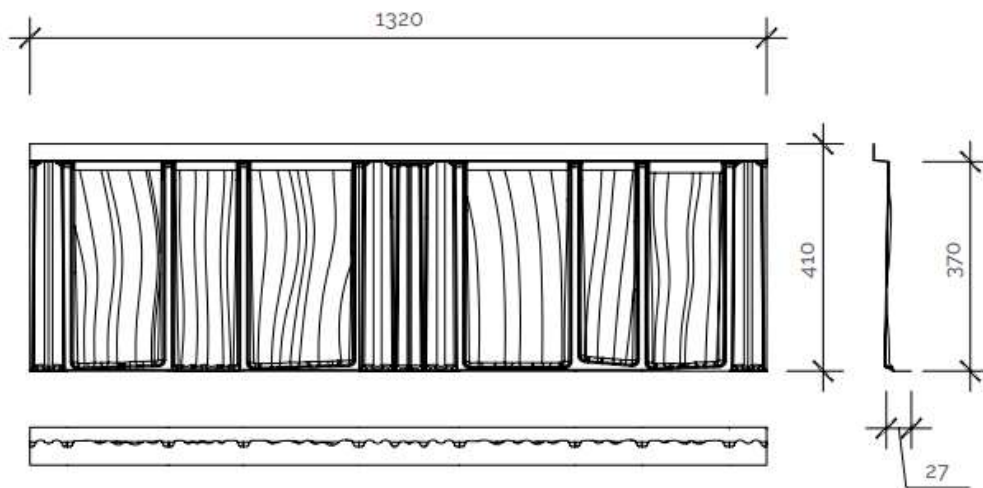
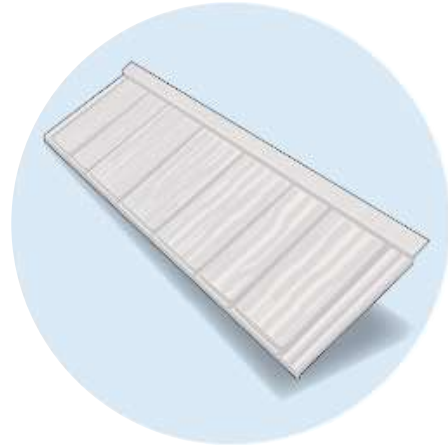
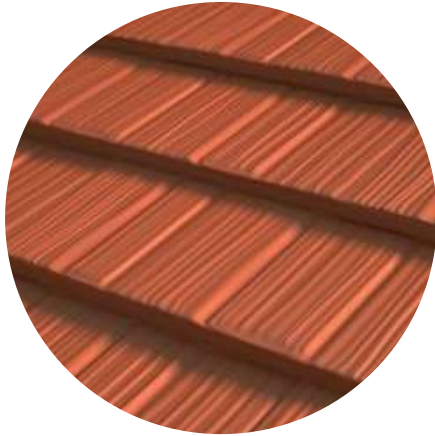

## FLASHING

**Homotech code:** 254CS/380 NEW 380mm

**Hole diameter:**  $\varnothing 250$   
(Suitable for 160DS Solatube,  
ED100/150/200 Duct reducer)

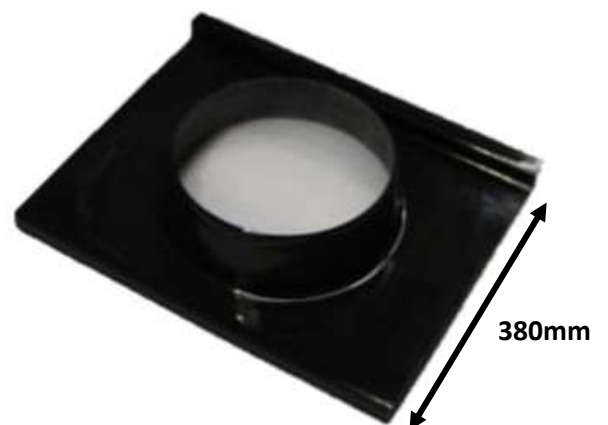

All dimensions in millimetres (nominal)

# 254OB

Pressed Metal Tile

## ROOFING PROFILE

Product: Metrotile Oberon

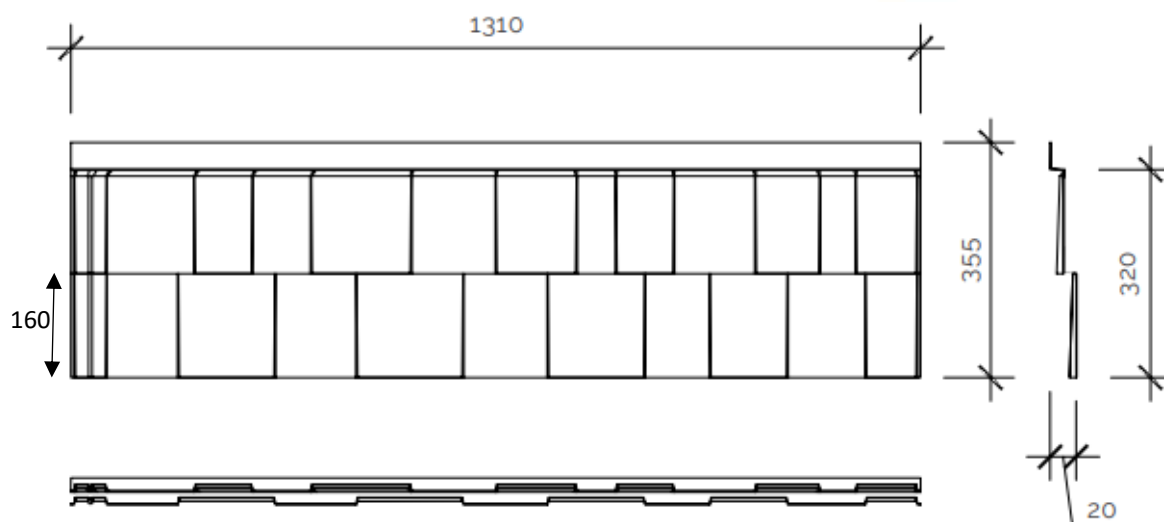
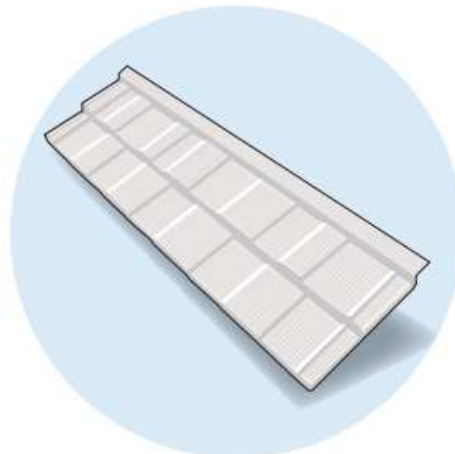

## FLASHING

Homotech code: 254OB

**Hole diameter:  $\varnothing 250$**   
(Suitable for 160DS Solatube,  
ED100/150/200 Duct reducer)





# 404OB

Pressed Metal Tile

## ROOFING PROFILE

Product: Metrotile Oberon

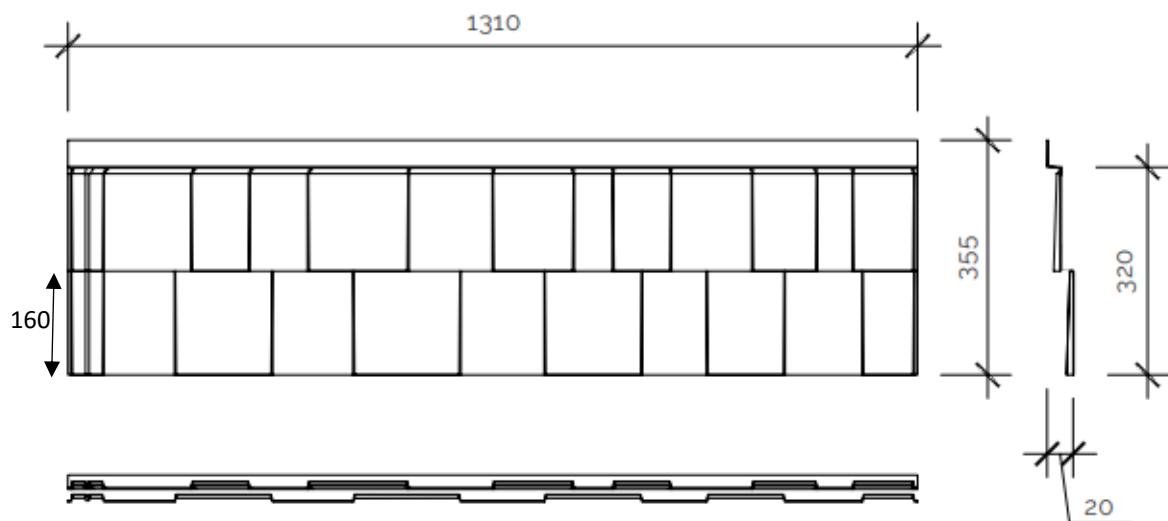
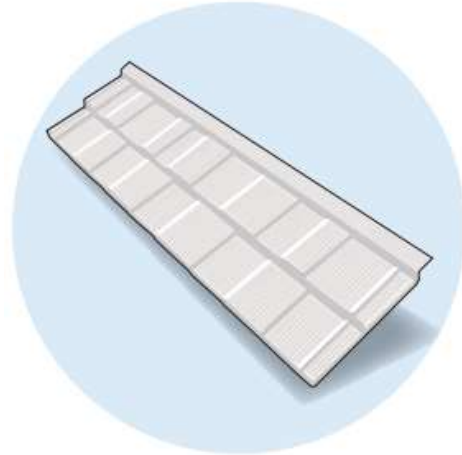

## FLASHING

Homotech code: 404OB

Hole diameter:  $\varnothing 400$

(Suitable for 290DS Solatube, requires DSCOLLAR, suitable for Solar Star RM1600)

Photo

# 254MOD

added Decmber 2019

Pressed Metal Tile

## ROOFING PROFILE

**Product:** Metalcraft Modena

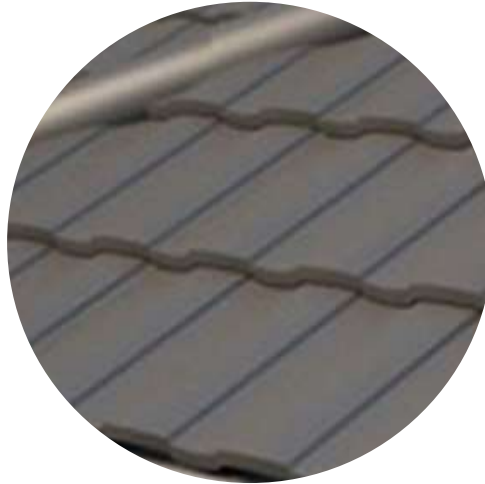

## FLASHING

**Homotech code:** 254MOD

**Hole diameter:**  $\varnothing 250$   
(Suitable for 160DS Solatube,  
ED100/150/200 Duct reducer)

**Photo**

**B**

**Concrete/Terracotta Tile**

# 254C

Concrete/Terracotta Tile

## ROOFING PROFILE

**Product:** Any Monier Concrete Tile

Reverse overlap also can be fitted (See page 2)

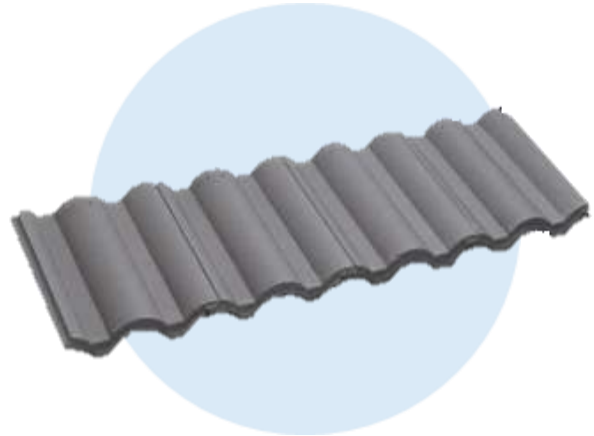

COVERAGE:	Approx. 10.6 tiles/sqm.
DIMENSION:	330mmW x 438mmL
MASS:	5.0 kg
LAP ADJUSTMENT:	Head lap 75 - 110mm
BOND:	Cross Bond
ROOF PITCH:	Min 15 degrees underlay required. Min without underlay 20 degrees. Always check rafter to pitch ratio, exposure of site and Local Government requirements



## FLASHING

**Homotech code:** 254C

**Hole diameter:**  $\varnothing 250$   
(Suitable for 160DS Solatube,  
ED100/150/200 Duct reducer)

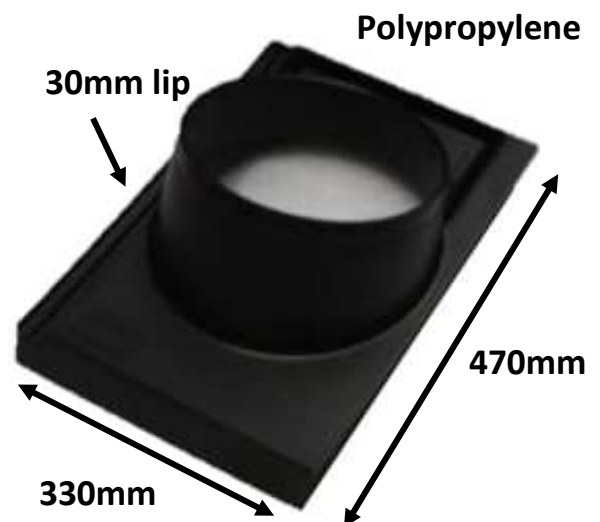

All dimensions in millimetres (nominal)

B2

# 254TC

Concrete/Terracotta Tile

## ROOFING PROFILE

**Product:** Any Monier Concrete Tile

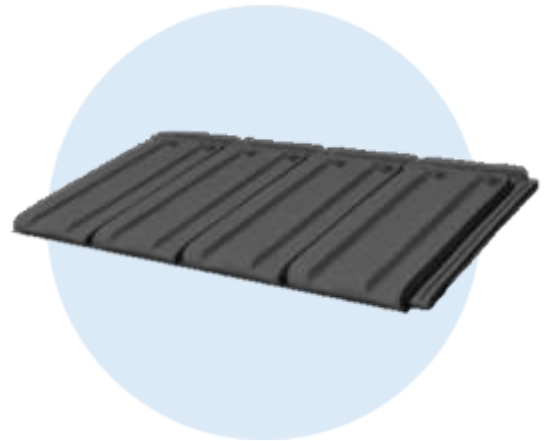
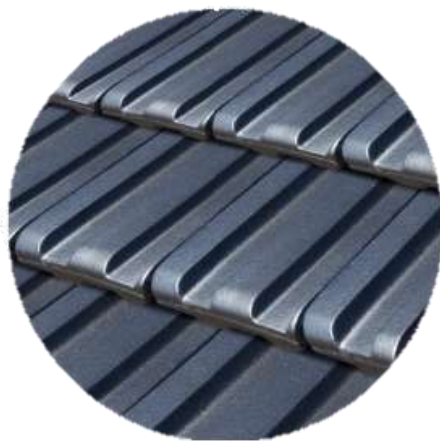

## FLASHING

**Homotech code:** 254TC

**Hole diameter:**  $\varnothing 250$   
(Suitable for 160DS Solatube,  
ED100/150/200 Duct reducer)

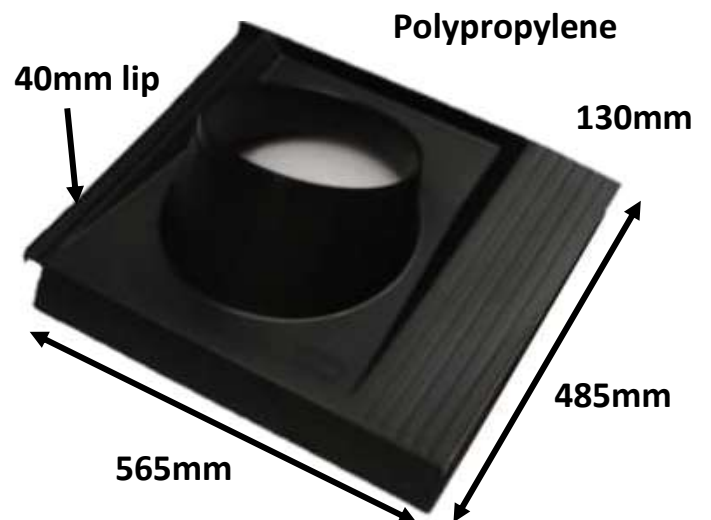

All dimensions in millimetres (nominal)

B3

# FL-290DS/T

Concrete/Terracotta Tile

## ROOFING PROFILE

**Product:** Any Monier Concrete or Terracotta Tile

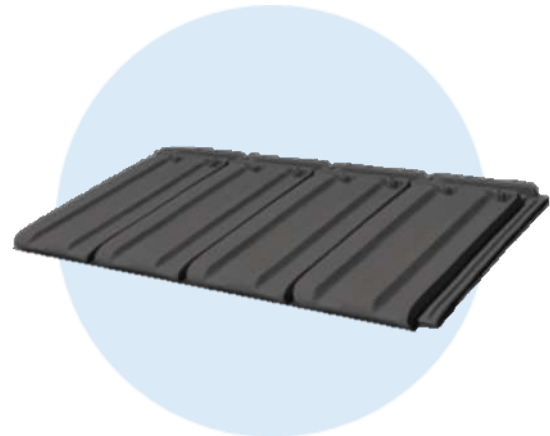
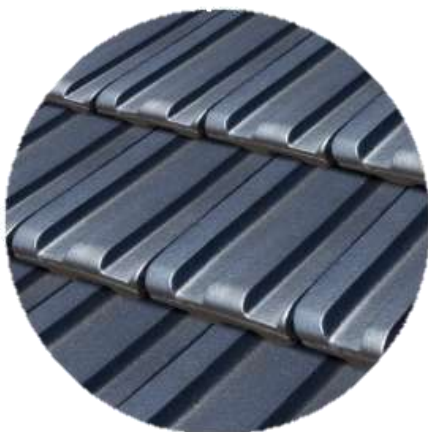
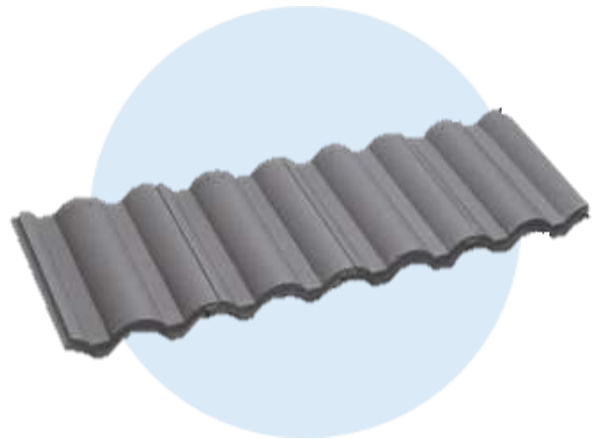

## FLASHING

**Homotech code:** FL-290DS/T

**Hole diameter:**  $\varnothing 350$   
(Suitable for 290DS Solatube,  
suitable for Solar Star RM1600)

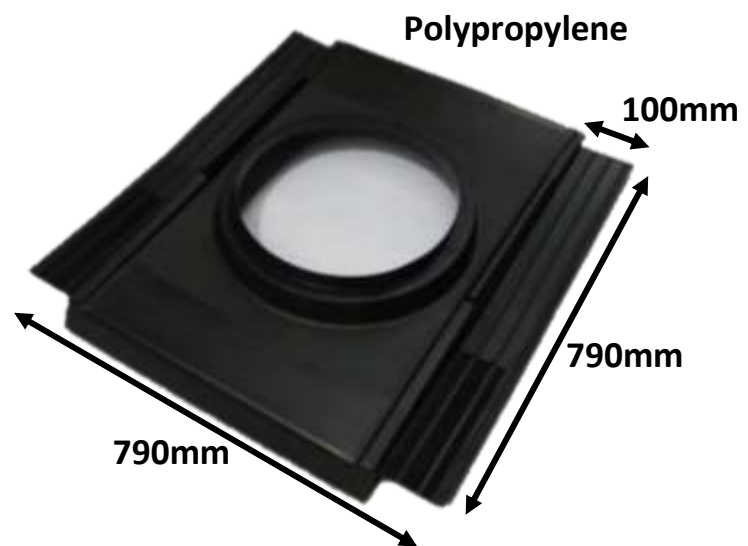

All dimensions in millimetres (nominal)

B4

# 404C

Concrete/Terracotta Tile

## ROOFING PROFILE

**Product:** Any Monier Concrete or Terracotta Tile

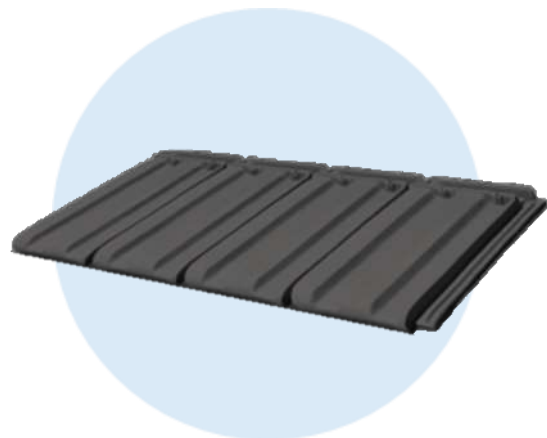
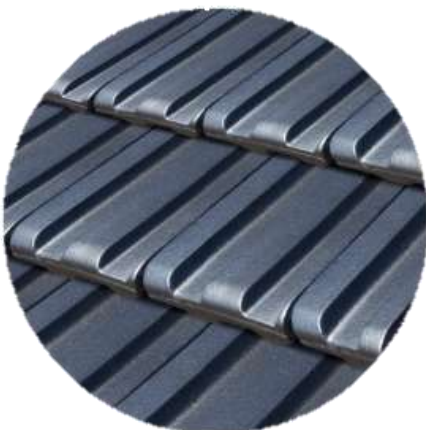
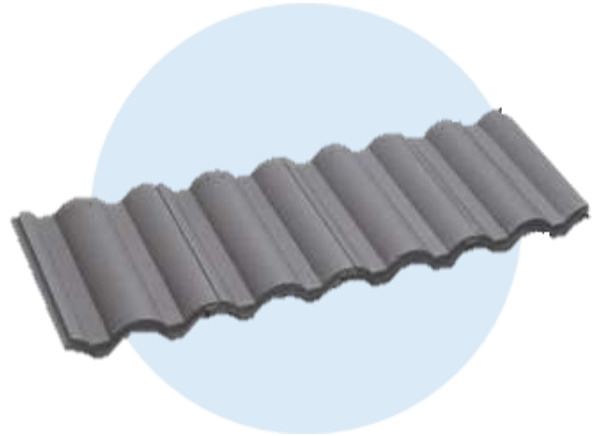

## FLASHING

**Homotech code:** 404C

**Hole diameter:**  $\varnothing 400$   
(Suitable for 290DS Solatube, requires DSCOLLAR, suitable for Solar Star RM1600)

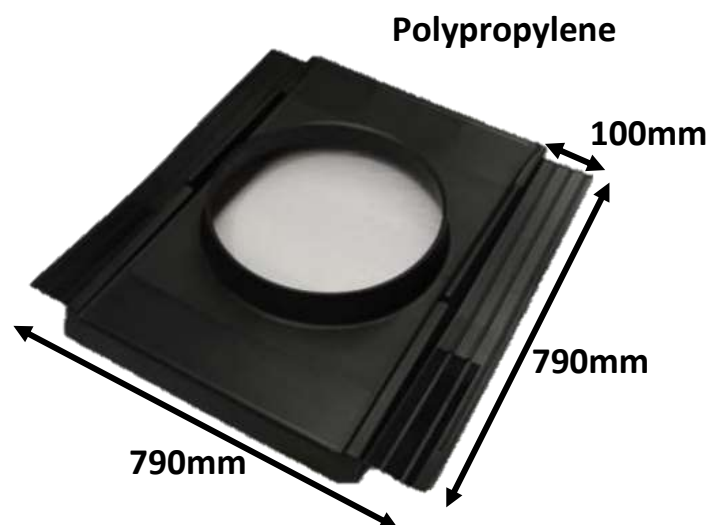



# 254FLX

Concrete/Terracotta Tile

## ROOFING PROFILE

**Product:** Reverse overlap concrete/terracotta tile  
Abnormal shape concrete/terracotta tile

Standard



Reverse



## FLASHING

**Hometech code:** 254FLX

**Hole diameter:**  $\varnothing 250$   
(Suitable for 160DS Solatube,  
ED100/150/200 Duct reducer)

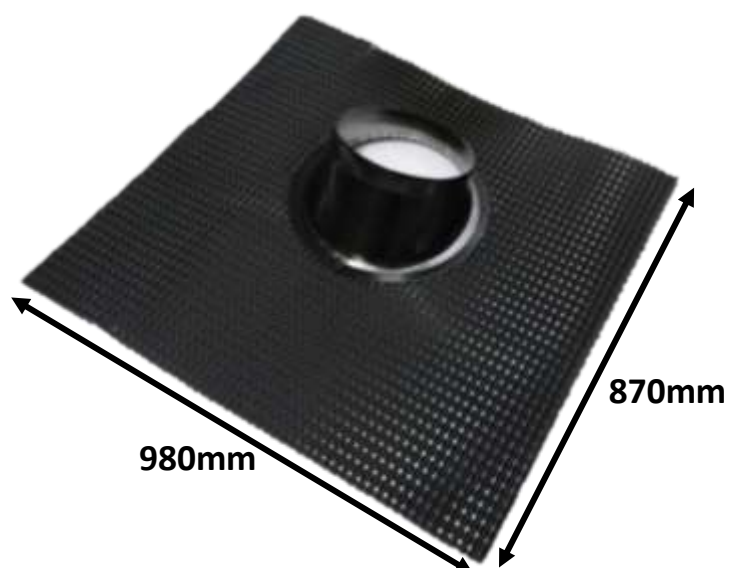

All dimensions in millimetres (nominal)

B6

# FL-230870

Concrete/Terracotta Tile

## ROOFING PROFILE

**Product:** Reverse overlap concrete/terracotta tile  
Abnormal shape concrete/terracotta tile

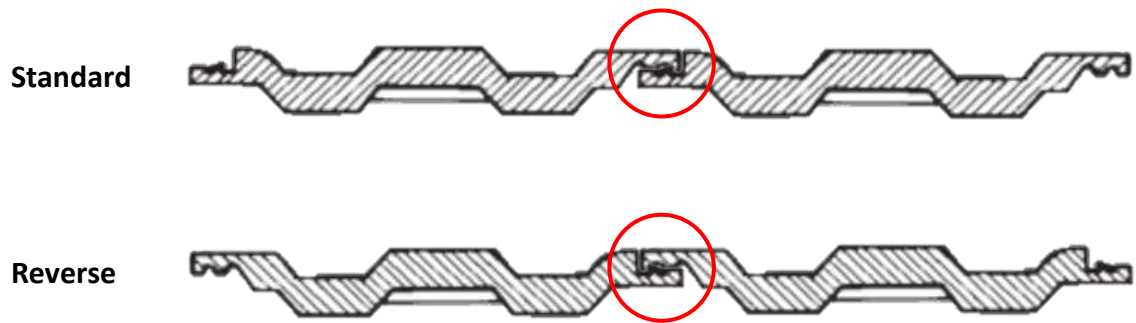

## FLASHING

**Homotech code:** FL-230870

**Hole diameter:**  $\varnothing 350$   
(Suitable for 290DS Solatube,  
suitable for Solar Star RM1600)

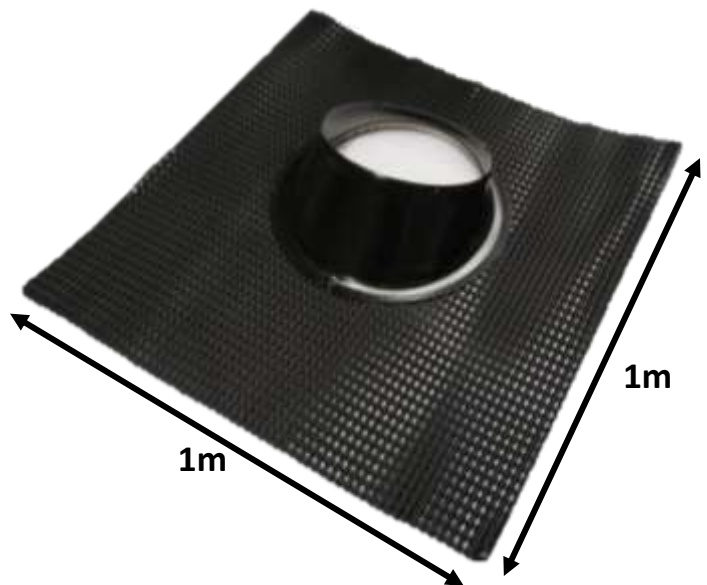

All dimensions in millimetres (nominal)

B7

C

Long Run

# 254TAY

Long Run

## ROOFING PROFILE

**Product:** Dimond Six Rib

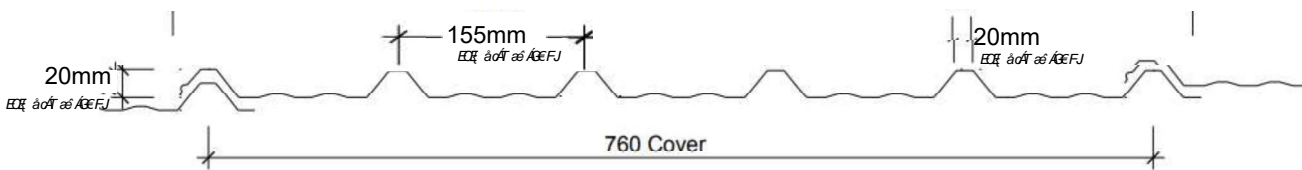
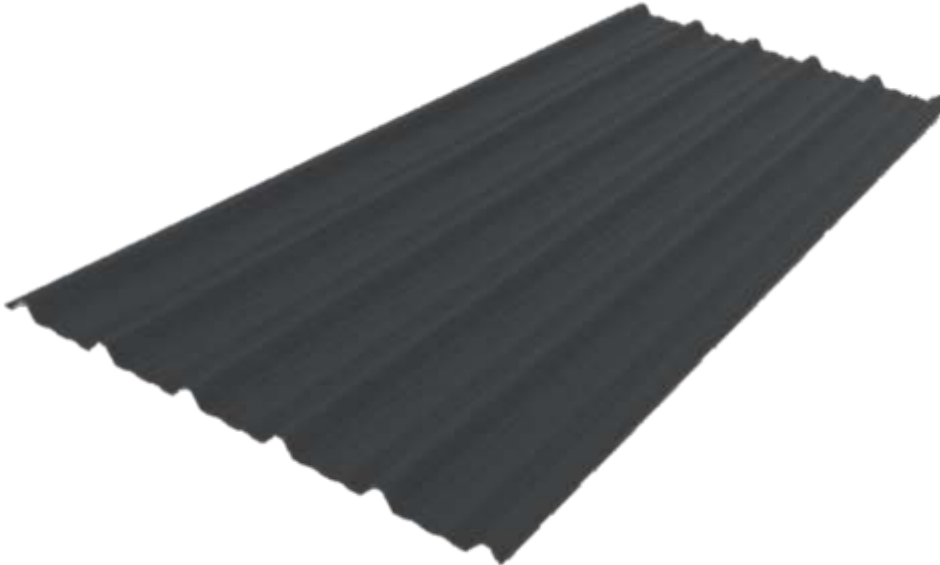

## FLASHING

**Homotech code:** 254TAY-F

with caps: 254TAY

**Hole diameter:**  $\varnothing 250$

(Suitable for 160DS Solatube,  
ED100/150/200 Duct reducer)



All dimensions in millimetres (nominal)

# 404TAY

Long Run

## ROOFING PROFILE

**Product:** Dimond Six Rib

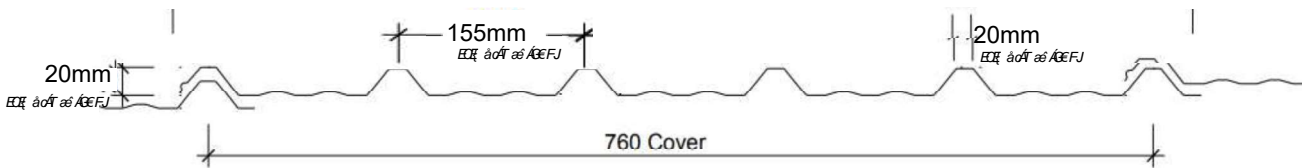

## FLASHING

**Homotech code:** 404TAY-F  
with caps: 404TAY

**Hole diameter:** Ø400  
(Suitable for 290DS Solatube,  
requires DSCOLLAR,  
suitable for Solar Star RM1600)



All dimensions in millimetres (nominal)

# 254150

Long Run

## ROOFING PROFILE

**Product:** Dimond Six Rib

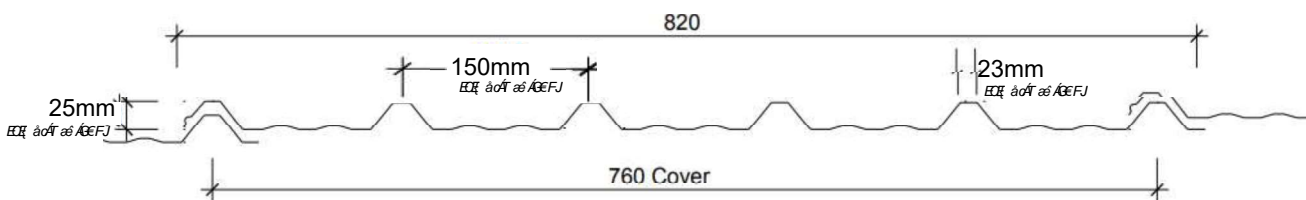
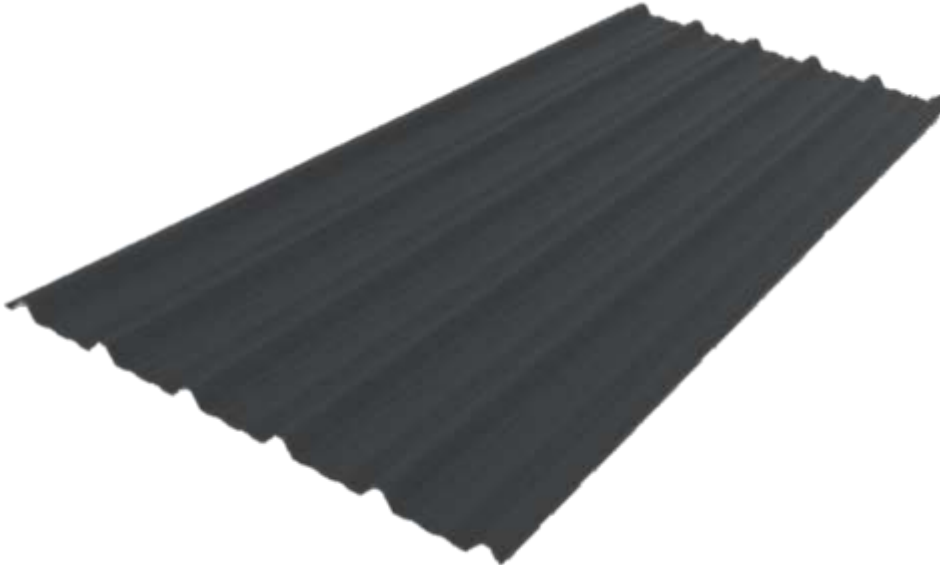

## FLASHING

**Homotech code:** 254150-F  
with caps: 254150

**Hole diameter:** Ø250  
(Suitable for 160DS Solatube,  
ED100/150/200 Duct reducer)

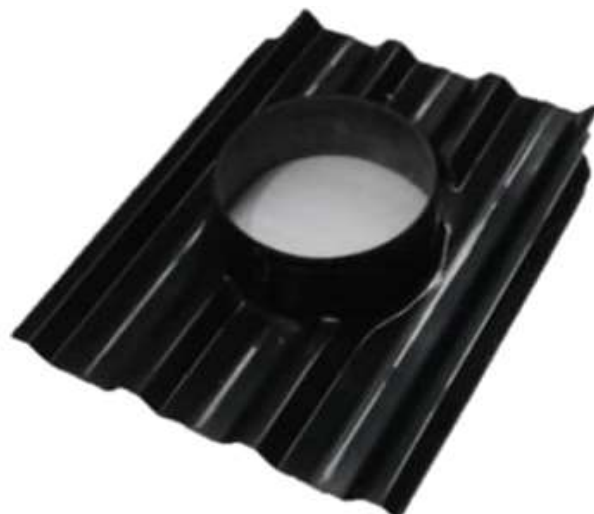

All dimensions in millimetres (nominal)

# 404150

Long Run

## ROOFING PROFILE

**Product:** Dimond Six Rib

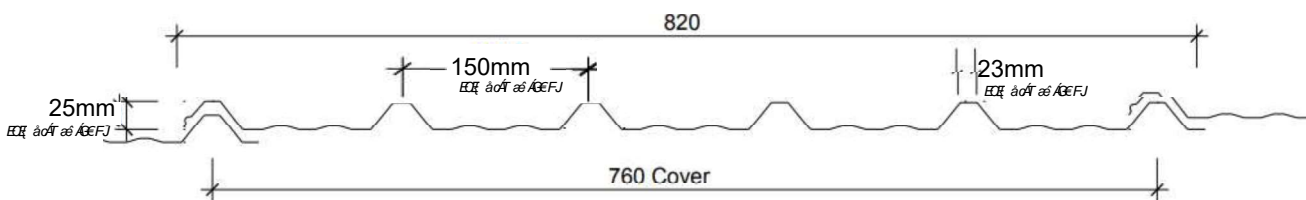
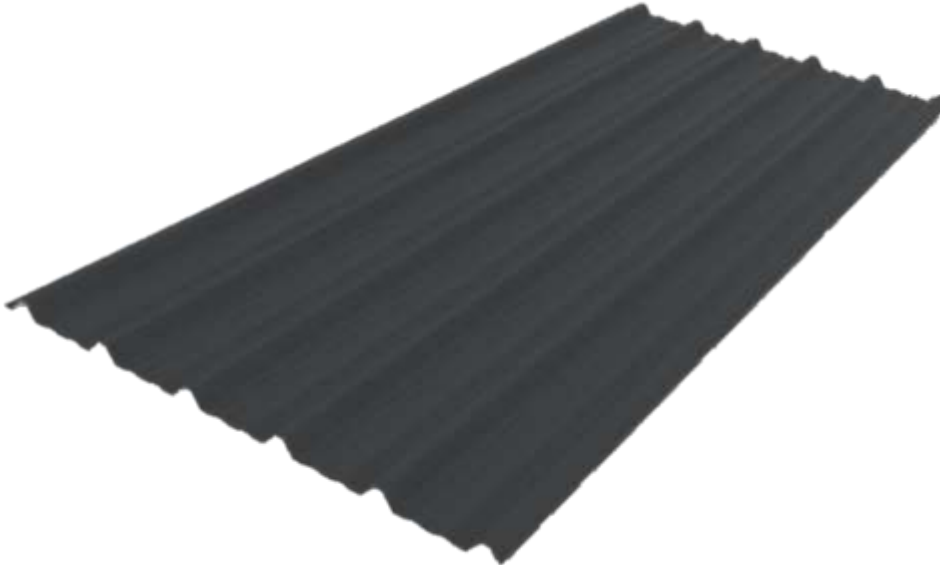

## FLASHING

**Homotech code:** 404150-F  
with caps: 404150

**Hole diameter:** Ø400  
(Suitable for 290DS Solatube,  
requires DSCOLLAR,  
suitable for Solar Star RM1600)



All dimensions in millimetres (nominal)



# 254LT7

Long Run

## ROOFING PROFILE

**Product:** Dimond LT7  
Dimond LT5

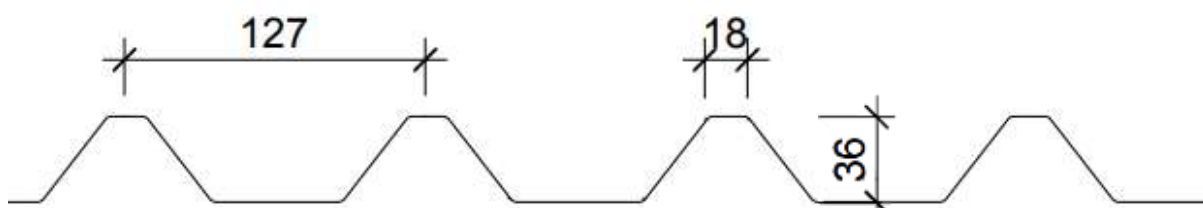
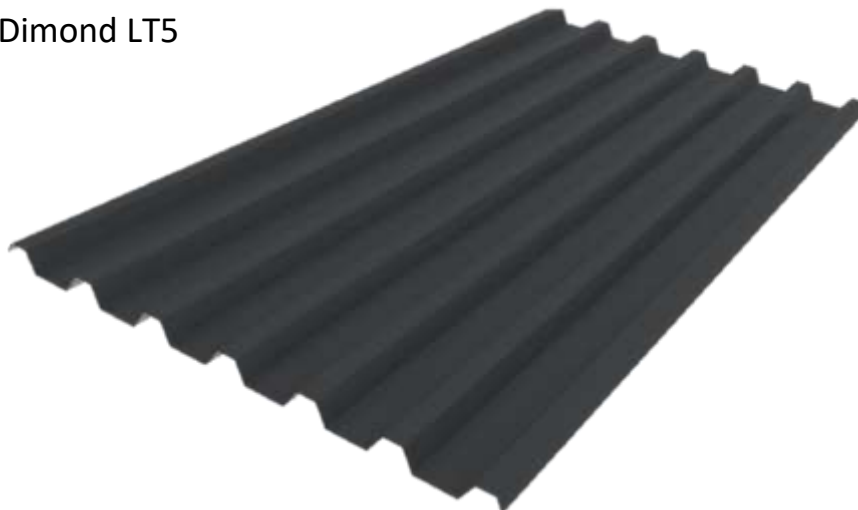

## FLASHING

**Homotech code:** 254LT7-F  
with caps: 254LT7

**Hole diameter:**  $\varnothing 250$   
(Suitable for 160DS Solatube,  
ED100/150/200 Duct reducer)



All dimensions in millimetres (nominal)

# 404LT7

Long Run

## ROOFING PROFILE

**Product:** Dimond LT7  
Dimond LT5

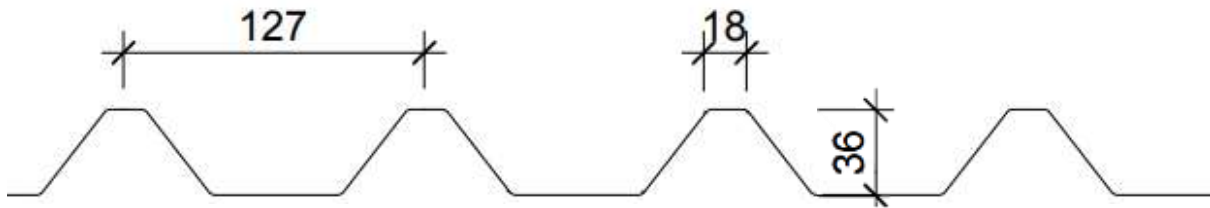
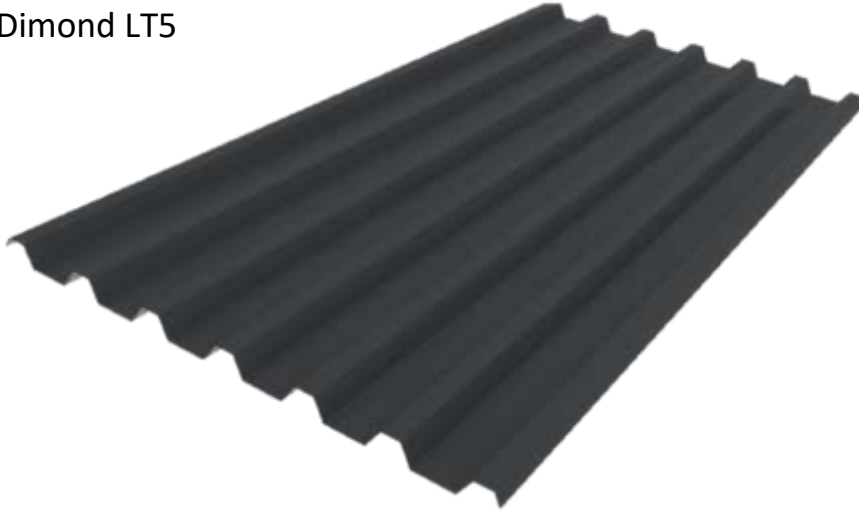

## FLASHING

**Homotech code:** 404LT7-F  
with caps: 404LT7

**Hole diameter:**  $\varnothing 400$   
(Suitable for 290DS Solatube,  
requires DSCOLLAR,  
suitable for Solar Star RM1600)



All dimensions in millimetres (nominal)

# 254V

Long Run

## ROOFING PROFILE

**Product:** Dimond V-Rib

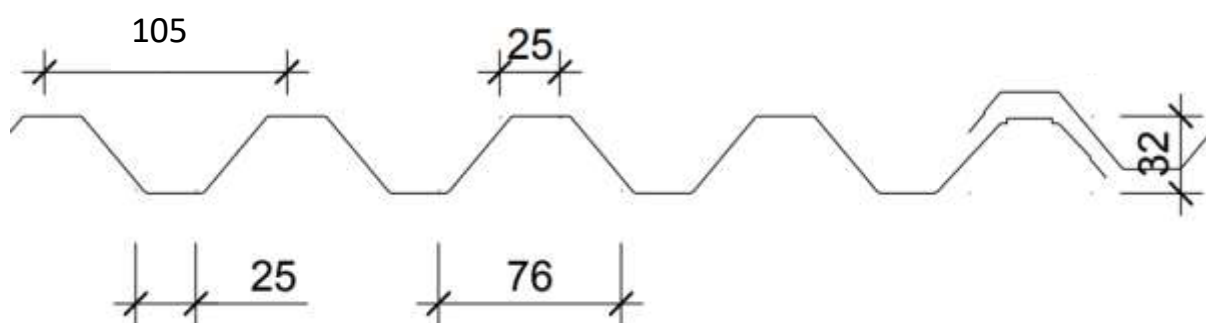

## FLASHING

**Homotech code:** 254V-F  
with caps: 254V

**Hole diameter:** Ø250  
(Suitable for 160DS Solatube,  
ED100/150/200 Duct reducer)



All dimensions in millimetres (nominal)

# 404V

Long Run

## ROOFING PROFILE

**Product:** Dimond V-Rib

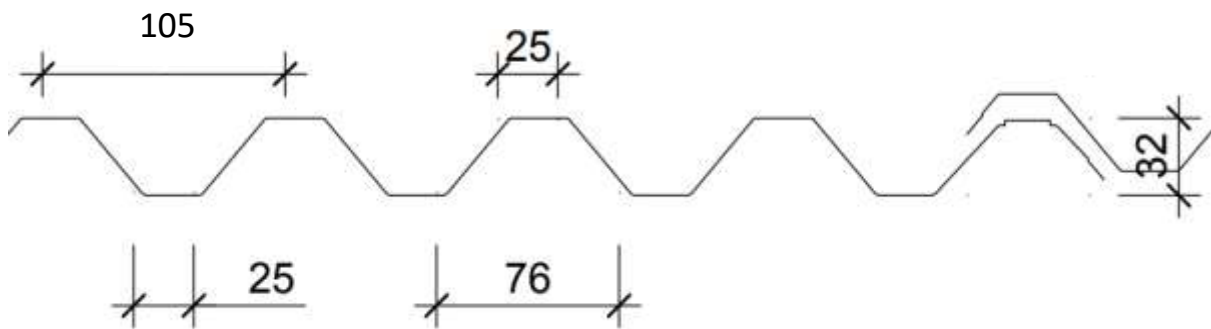

## FLASHING

**Homotech code:** 404V-F  
with caps: 404V

**Hole diameter:**  $\varnothing 400$   
(Suitable for 290DS Solatube,  
requires DSCOLLAR,  
suitable for Solar Star RM1600)



All dimensions in millimetres (nominal)

# 254BB

Long Run

## ROOFING PROFILE

**Product:** Dimond Brownbuilt 900

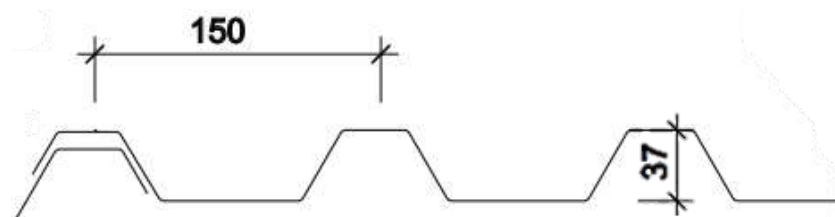

## FLASHING

**Homotech code:** 254BB-F  
with caps: 254BB

**Hole diameter:**  $\varnothing 250$   
(Suitable for 160DS Solatube,  
ED100/150/200 Duct reducer)

**\*Extended  
turret**



All dimensions in millimetres (nominal)

# 404BB

Long Run

## ROOFING PROFILE

**Product:** Dimond Brownbuilt 900

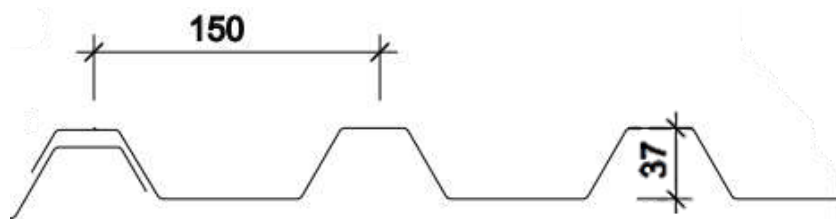

## FLASHING

**Homotech code:** 404BB-F  
with caps: 404BB

**Hole diameter:**  $\varnothing 400$   
(Suitable for 290DS Solatube,  
requires DSCOLLAR,  
suitable for Solar Star RM1600)



All dimensions in millimetres (nominal)

# 606BB

Long Run

## ROOFING PROFILE

**Product:** Dimond Brownbuilt 900

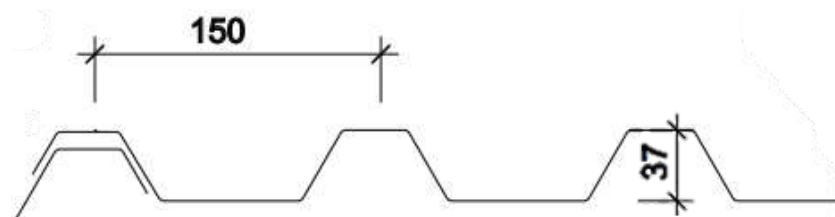

## FLASHING

**Homotech code:** 606BB-F  
with caps: 606BB

**Hole diameter:** Ø600  
(Suitable for 330DS, 750DS  
Solatube)



All dimensions in millimetres (nominal)



# 254225

Long Run

## ROOFING PROFILE

**Product:** Dimond Topspan  
Roofing Industries Maxispan

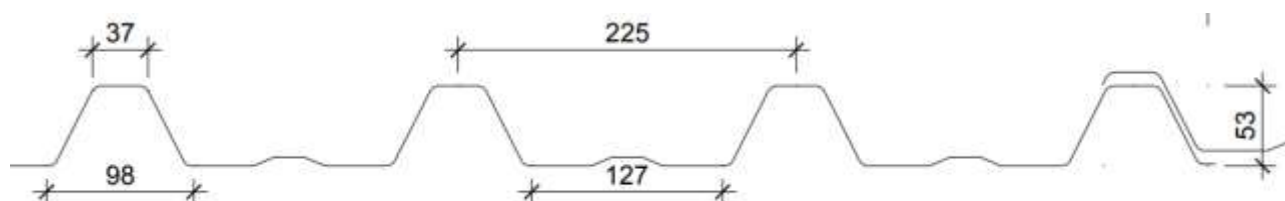
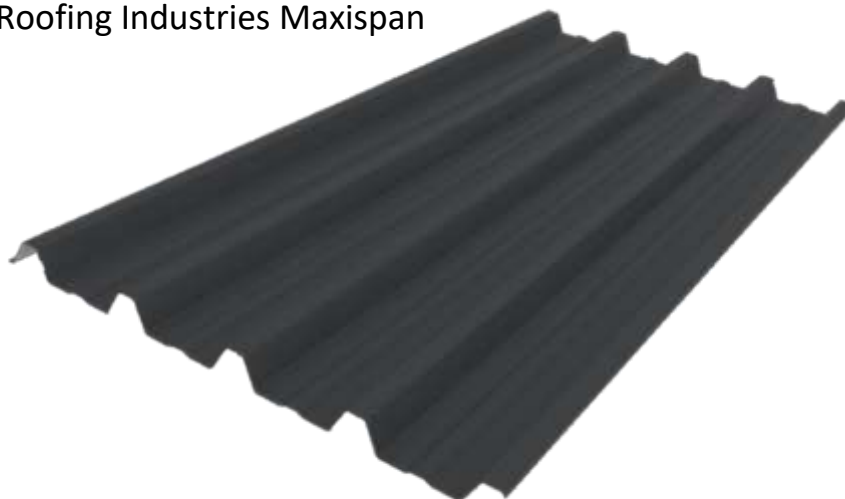

## FLASHING

**Homotech code:** 254225-F  
with caps: 254225

**Hole diameter:**  $\varnothing 250$   
(Suitable for 160DS Solatube,  
ED100/150/200 Duct reducer)

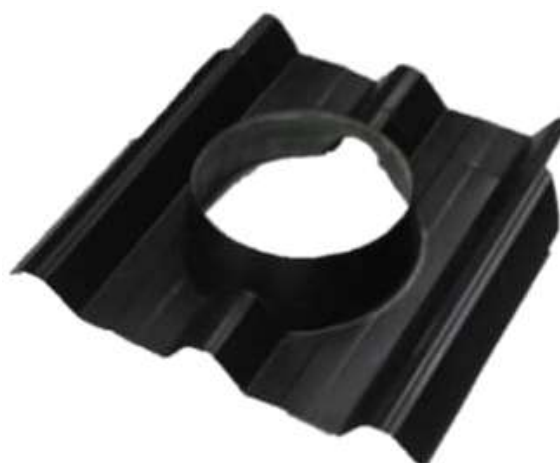

All dimensions in millimetres (nominal)

# 404225

Long Run

## ROOFING PROFILE

**Product:** Dimond Topspan  
Roofing Industries Maxispan

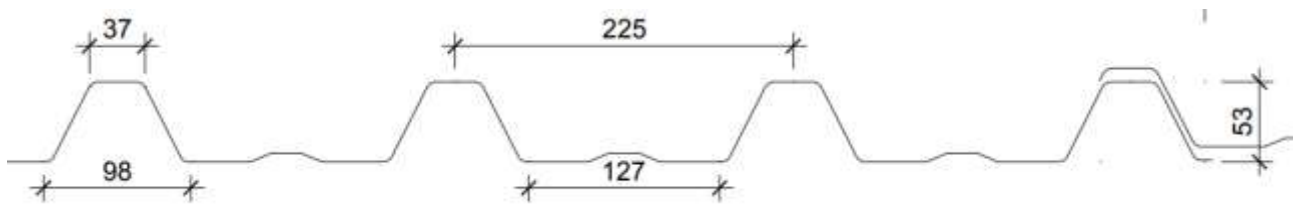
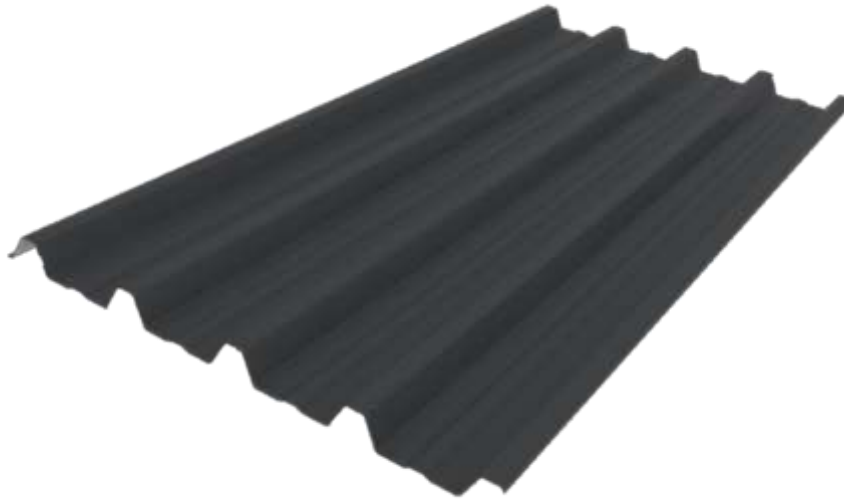

## FLASHING

**Homotech code:** 404225-F  
with caps: 404225

**Hole diameter**  $\varnothing$ 400  
(Suitable for 290DS Solatube, requires  
DSCOLLAR,  
suitable for Solar Star RM1600)

**Photo**

All dimensions in millimetres (nominal)

# 606225

Long Run

## ROOFING PROFILE

**Product:** Dimond Topspan  
Roofing Industries Maxispan

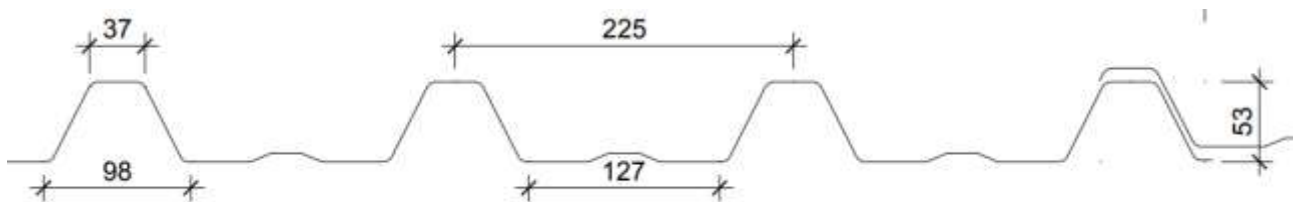
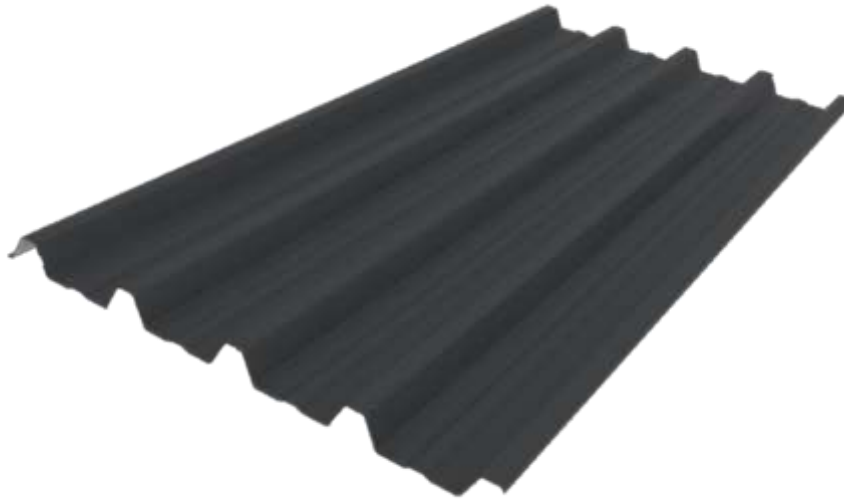

## FLASHING

**Hometech code:** 606225-F  
with caps: 606225

**Hole diameter**  $\varnothing 600$   
(Suitable for 330DS, 750DS Solatube)

**Photo**

All dimensions in millimetres (nominal)

# 254SL

Long Run

## ROOFING PROFILE

**Product:** Dimond Styleline  
Taranaki Steelformers Styleline

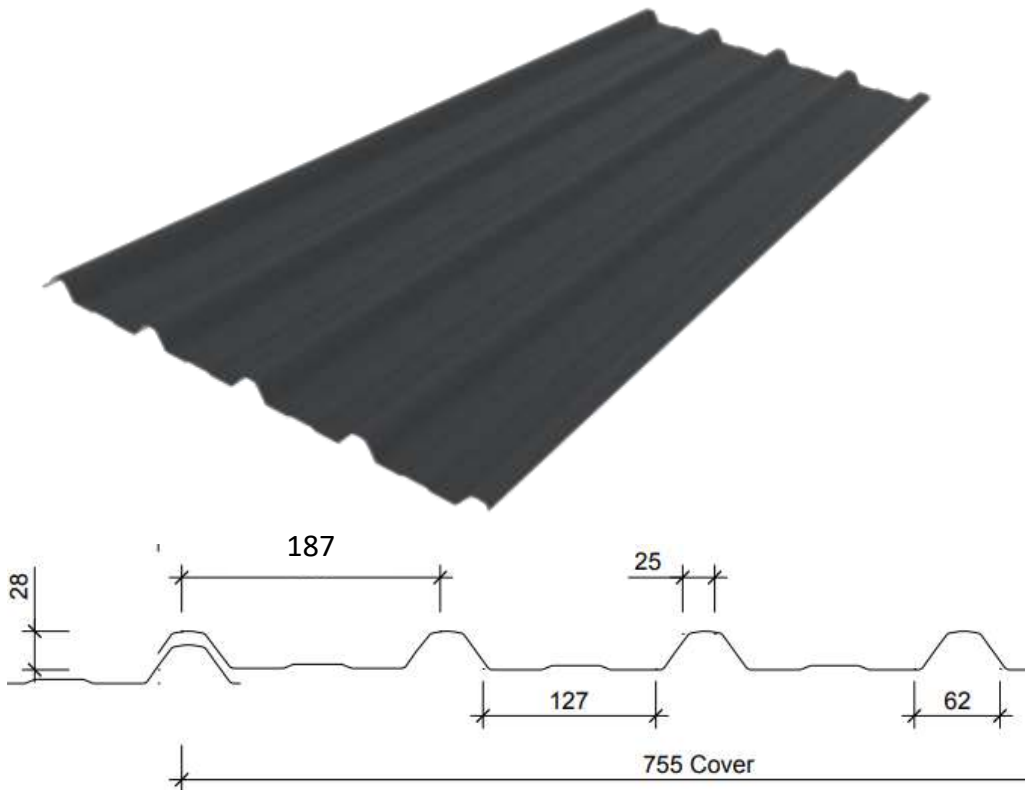

## FLASHING

**Homotech code:** 254SL-F  
with caps: 254SL

**\*Extended  
Turret**

**Hole diameter:**  $\varnothing 250$   
(Suitable for 160DS Solatube,  
ED100/150/200 Duct reducer)



All dimensions in millimetres (nominal)

# 254DD

Long Run

## ROOFING PROFILE

**Product:** Dimond DP955

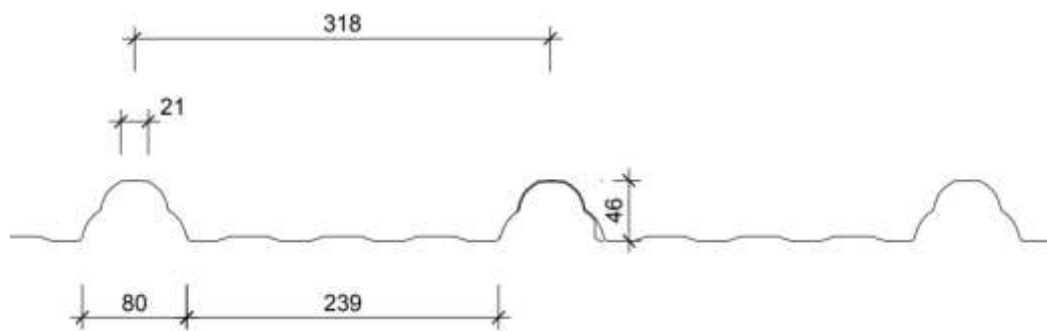

## FLASHING

**Homotech code:** 254DD-F  
with caps: 254DD

**Hole diameter** Ø250  
(Suitable for 160DS Solatube,  
ED100/150/200 Duct reducer)

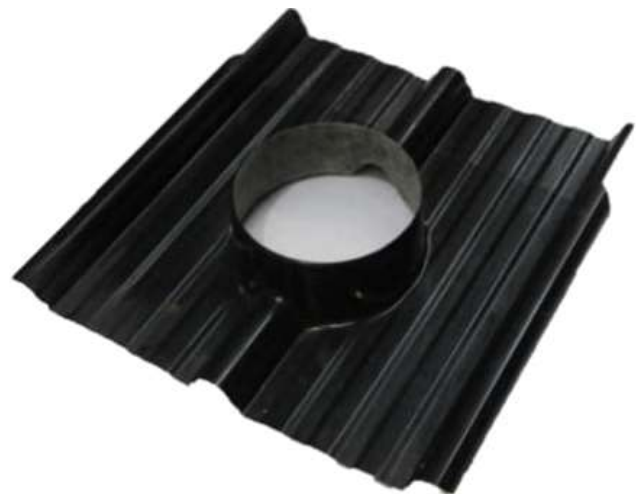

All dimensions in millimetres (nominal)

# 404DD

Long Run

## ROOFING PROFILE

**Product:** Dimond DP955

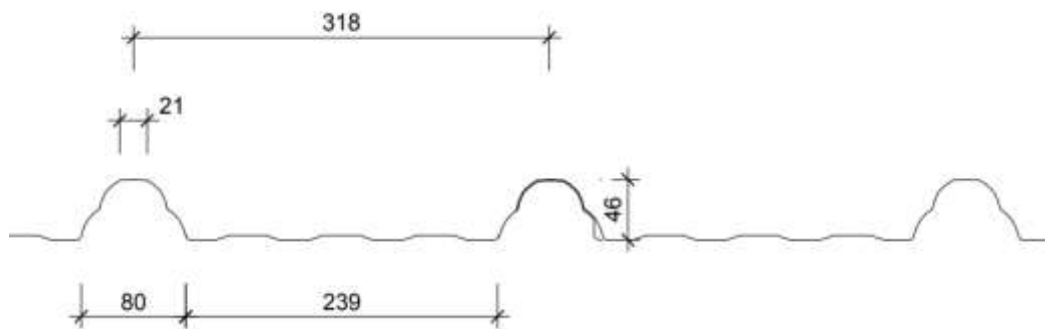

## FLASHING

**Homotech code:** 404DD-F  
with caps: 404DD

**Hole diameter**  $\varnothing 400$   
(Suitable for 290DS Solatube,  
requires DSCOLLAR,  
suitable for Solar Star RM1600)

**Photo**

All dimensions in millimetres (nominal)

# 254147

Long Run

## ROOFING PROFILE

**Product:** Steel & Tube Trimline

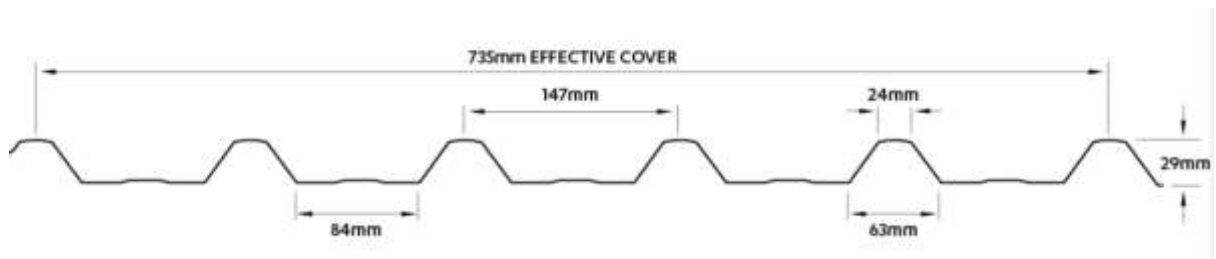

## FLASHING

**Homotech code:** 254147-F  
with caps: 254147

**Hole diameter:**  $\varnothing 250$   
(Suitable for 160DS Solatube,  
ED100/150/200 Duct reducer)



All dimensions in millimetres (nominal)



# 404147

Long Run

## ROOFING PROFILE

**Product:** Steel & Tube Trimline

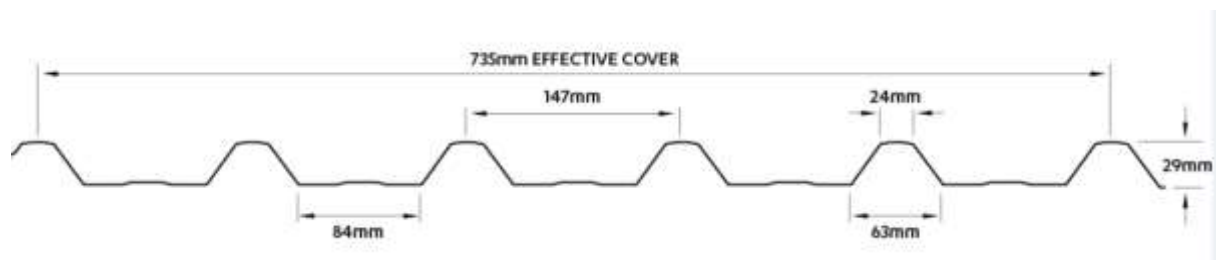

## FLASHING

**Hometech code:** 404147-F  
with caps: 404147

**Hole diameter:**  $\varnothing 400$   
(Suitable for 290DS Solatube, requires DSCOLLAR, suitable for Solar Star RM1600)



All dimensions in millimetres (nominal)

# 606147

Long Run

## ROOFING PROFILE

**Product:** Steel & Tube Trimline

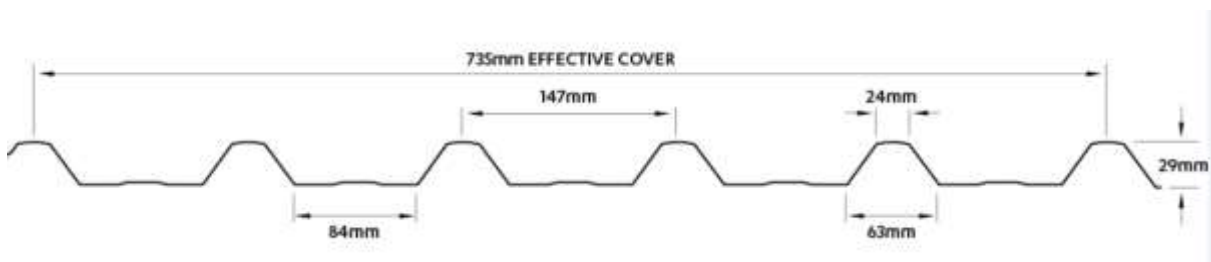

## FLASHING

**Homotech code:** 606147-F  
with caps: 606147

**Hole diameter:**  $\varnothing 600$   
(Suitable for 330DS, 750DS Solatube)

**Photo**

All dimensions in millimetres (nominal)

# 254PD

Long Run

## ROOFING PROFILE

**Product:** Steel & Tube Plumbdek

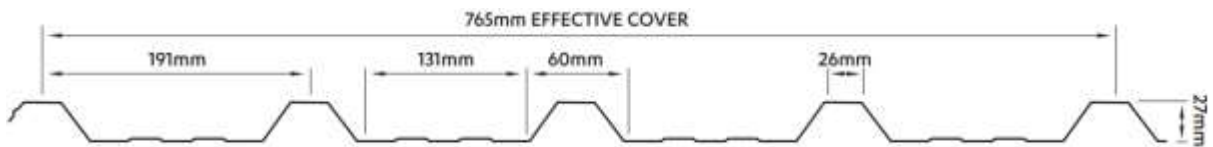
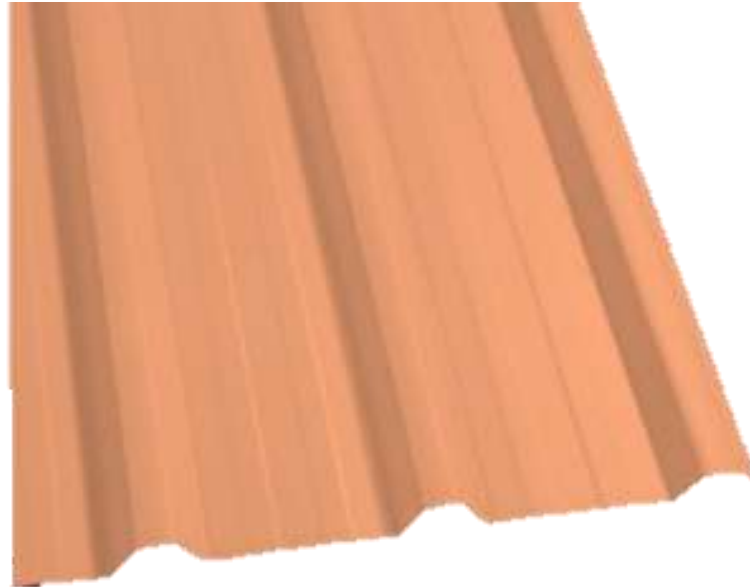

## FLASHING

**Homotech code:** 254PD-F  
with caps: 254PD

**Hole diameter:**  $\varnothing 250$   
(Suitable for 160DS Solatube,  
ED100/150/200 Duct reducer)

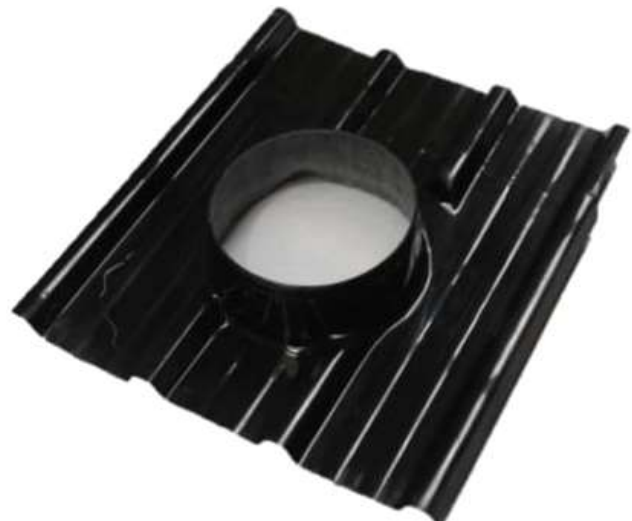

All dimensions in millimetres (nominal)

# 404PD

Long Run

## ROOFING PROFILE

**Product:** Steel & Tube Plumbdek

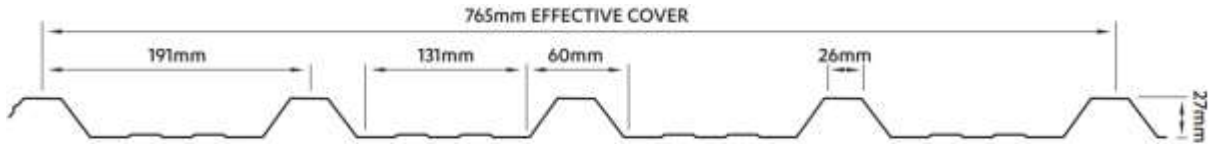
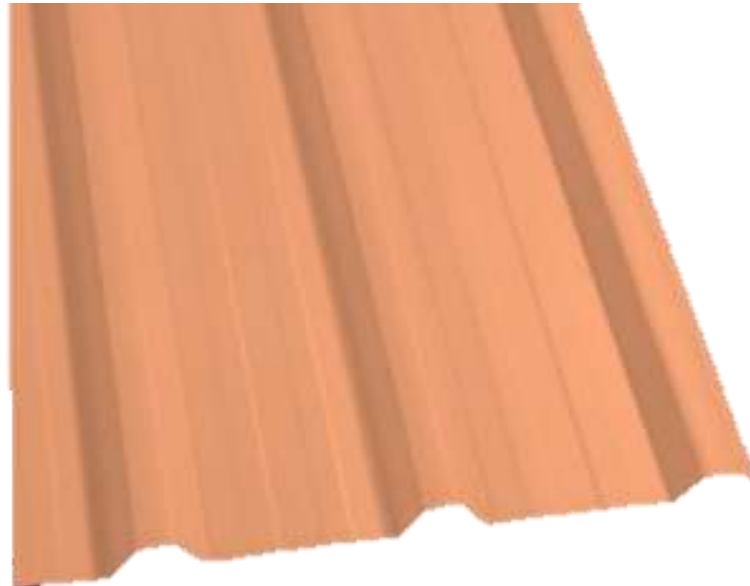

## FLASHING

**Homotech code:** 404PD-F  
with caps: 404PD

**Hole diameter:**  $\varnothing 400$   
(Suitable for 290DS Solatube,  
requires DSCOLLAR,  
suitable for Solar Star RM1600)

**Photo**

All dimensions in millimetres (nominal)

# 254160

Long Run

## ROOFING PROFILE

**Product:** Roofing Industries Ribline 800

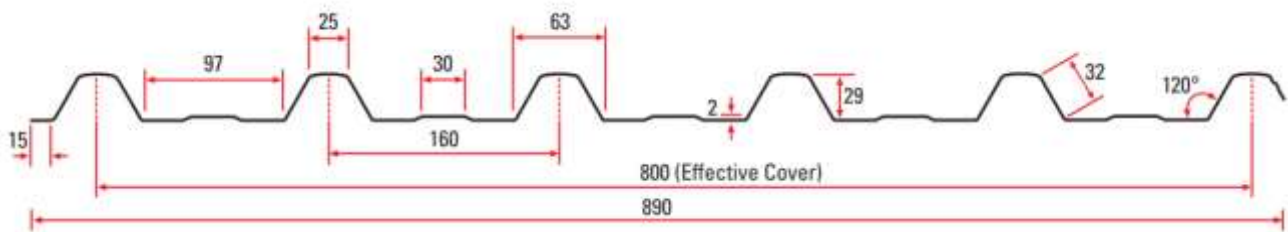
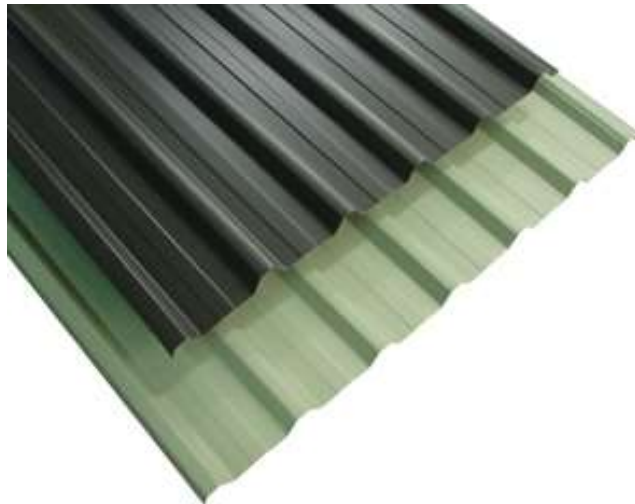

## FLASHING

**Homotech code:** 254160-F  
with caps: 254160

**Hole diameter:**  $\varnothing 250$   
(Suitable for 160DS Solatube,  
ED100/150/200 Duct reducer)



All dimensions in millimetres (nominal)

# 404160

Long Run

## ROOFING PROFILE

**Product:** Roofing Industries Ribline 800

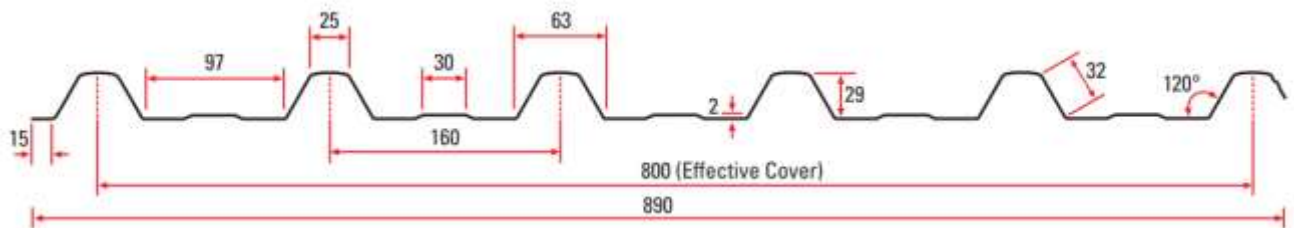
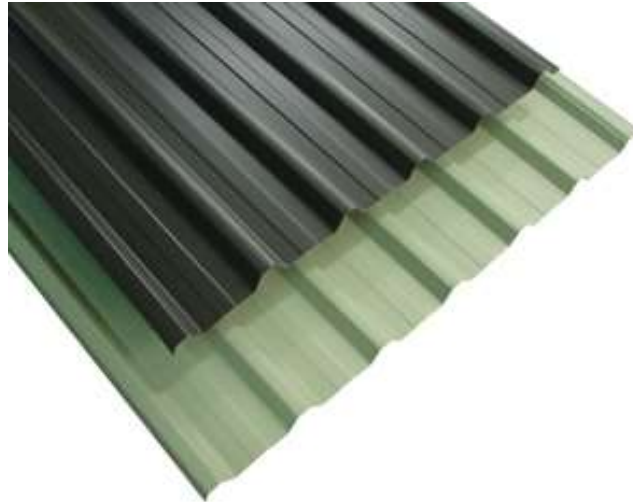

## FLASHING

**Homotech code:** 404160-F

with caps: 404160

**Hole diameter:** Ø400

(Suitable for 290DS Solatube, requires

DSCOLLAR,

suitable for Solar Star RM1600)

**Photo**

All dimensions in millimetres (nominal)

# 606160

Long Run

## ROOFING PROFILE

**Product:** Roofing Industries Ribline 800

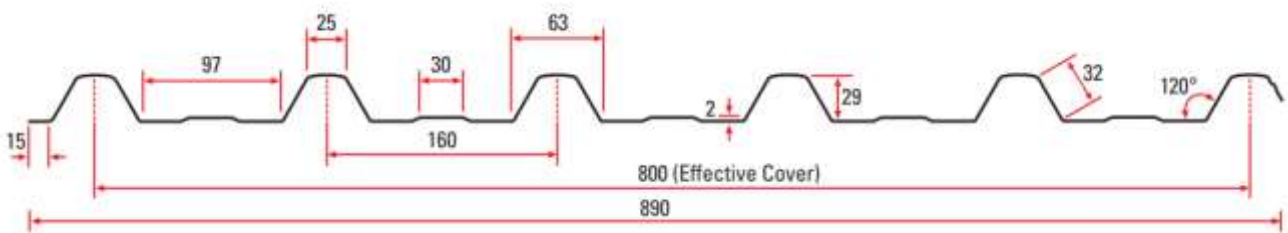
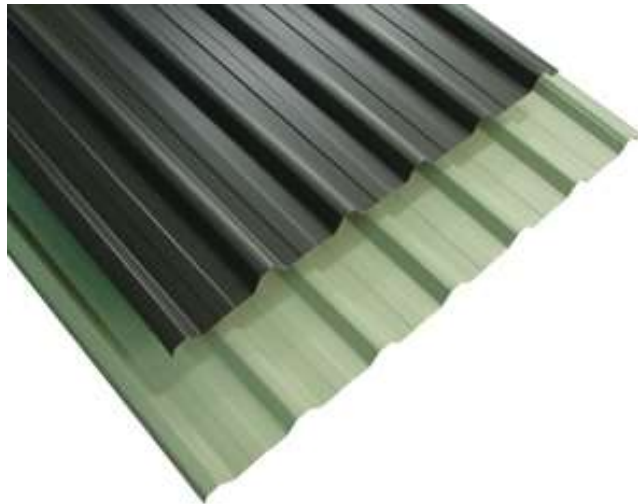

## FLASHING

**Homotech code:** 606160-F  
with caps: 606160

**Hole diameter:**  $\varnothing 600$   
(Suitable for 330DS, 750DS Solatube)



All dimensions in millimetres (nominal)

## ROOFING PROFILE

**Product:** Roofing Industries Multirib

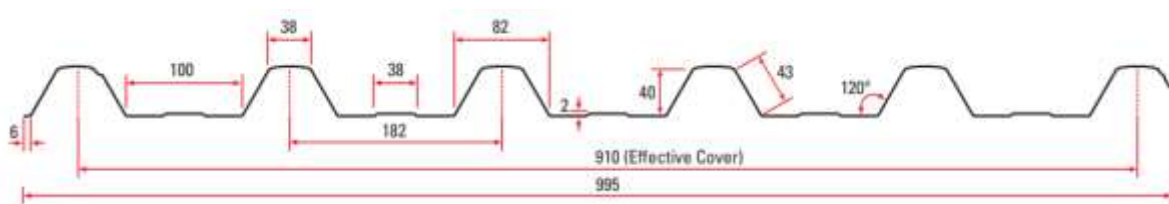
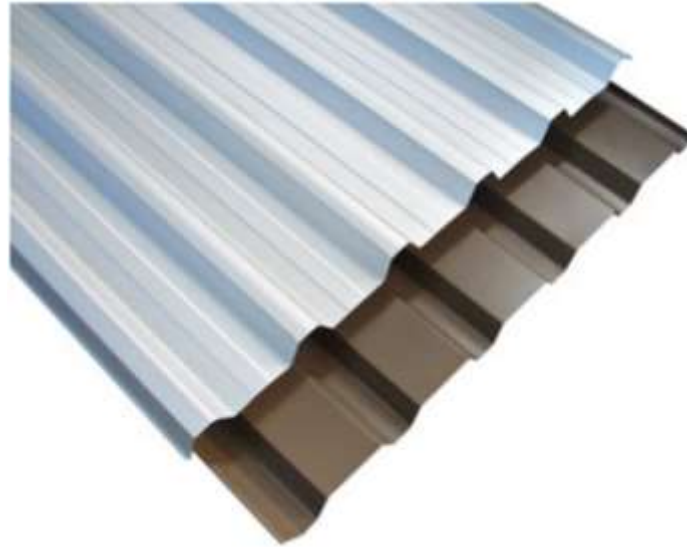

## FLASHING

**Homotech code:** 254182-F  
with caps: 254182

**Hole diameter** Ø250  
(Suitable for 160DS Solatube,  
ED100/150/200 Duct reducer)



All dimensions in millimetres (nominal)



## ROOFING PROFILE

**Product:** Roofing Industries Multirib

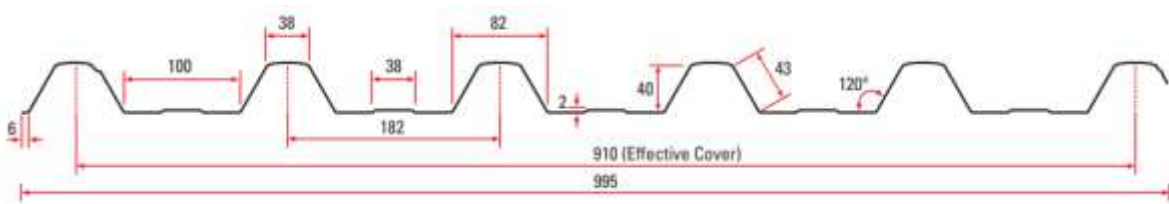
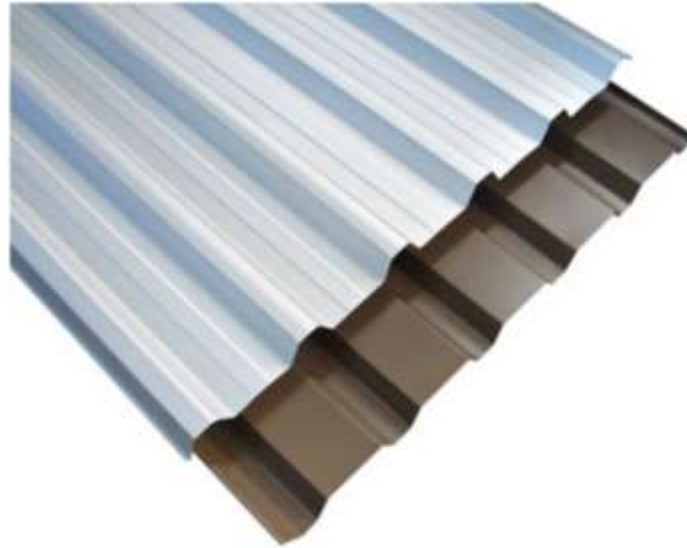

## FLASHING

**Homotech code:** 404182-F  
with caps: 404182

**Hole diameter:** Ø400  
(Suitable for 290DS Solatube,  
requires DSCOLLAR,  
suitable for Solar Star RM1600)

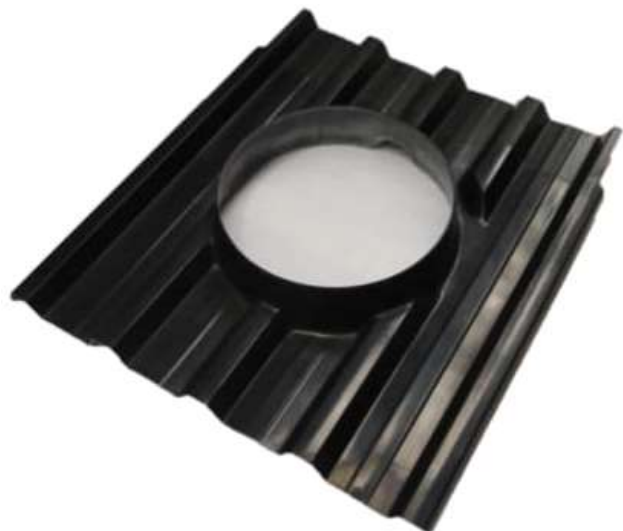

All dimensions in millimetres (nominal)

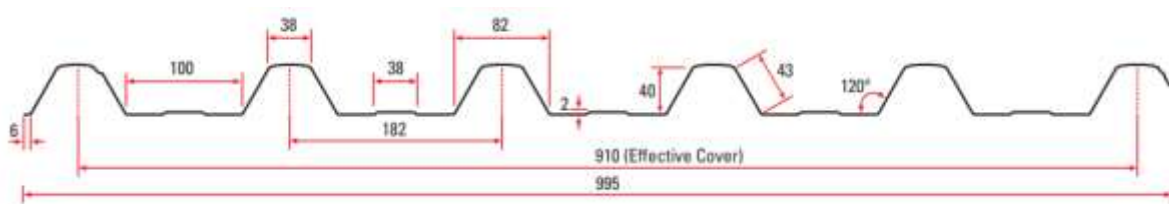
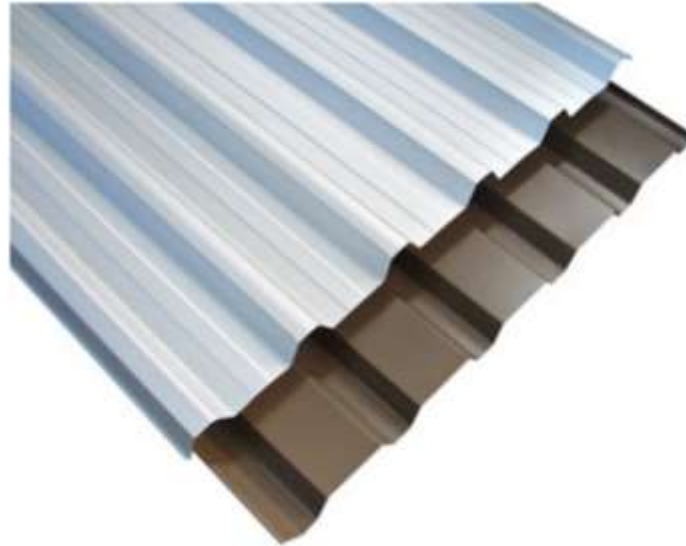
**ROOFING PROFILE****Product:** Roofing Industries Multirib**FLASHING****Homotech code:** 606182-F  
with caps: 606182**Hole diameter:** Ø600  
(Suitable for 330DS, 750DS Solatube)**Photo**

All dimensions in millimetres (nominal)

# 254MT

Long Run

## ROOFING PROFILE

Products: Lysaght Trimdek

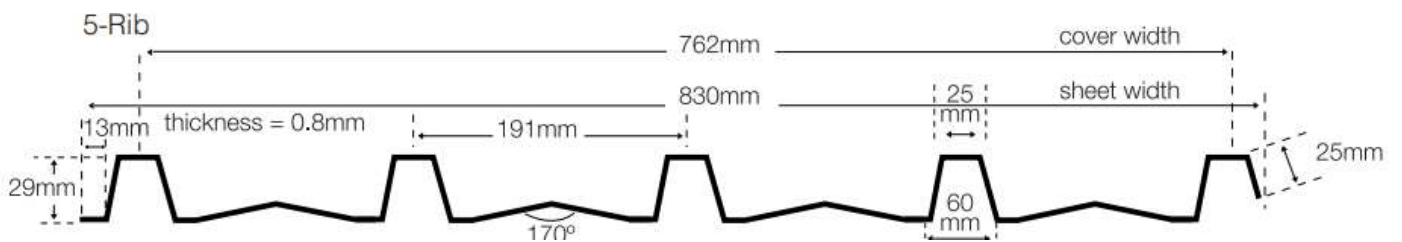
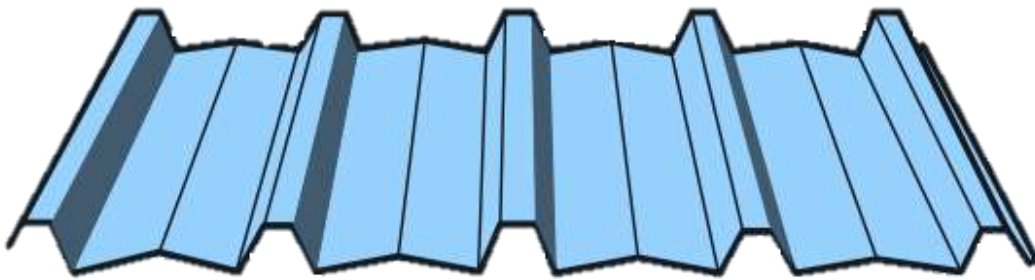

## FLASHING

**Homotech code:** 254MT  
with caps: 254MT

**Hole diameter:**  $\varnothing 250$   
(Suitable for 160DS Solatube,  
ED100/150/200 Duct reducer)

**Polypropylene**



All dimensions in millimetres (nominal)

# FL-290DS/MT

Long Run

## ROOFING PROFILE

Products: Lysaght Trimdek

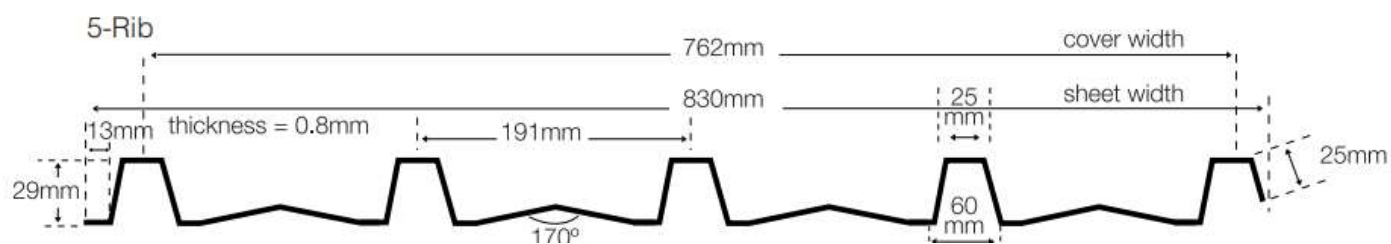
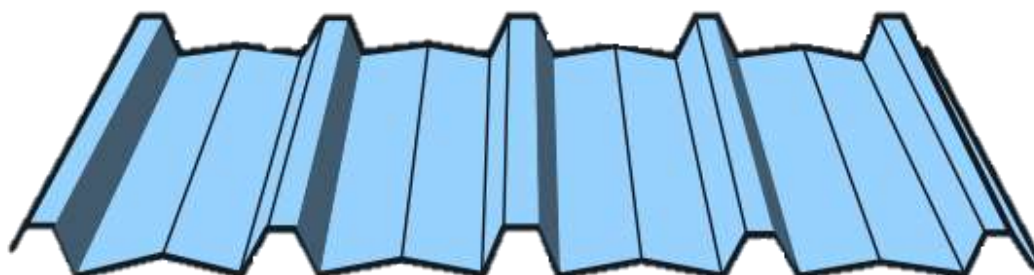

## FLASHING

Homotech code: FL-290DS/MT  
with caps: FL-290DS/MT

Hole diameter:  $\varnothing 350$   
(Suitable for 290DS Solatube,  
suitable for Solar Star RM1600)

Polypropylene



All dimensions in millimetres (nominal)

**ROOFING PROFILE**

**Products:** Lysaght Trimdek

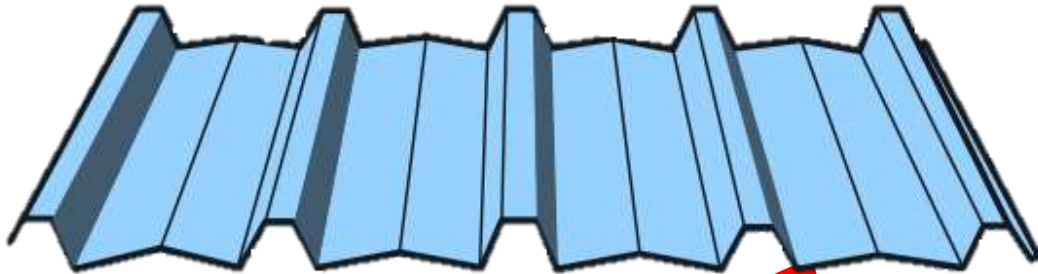

**FLASHING**

**Homotech code:** 404MT  
with caps: 404MT

**Polypropylene**

**Supplier/Manufacturer code:** FL-400MT

**Hole diameter:** Ø400  
(Suitable for 290DS Solatube, requires DSCOLLAR, suitable for Solar Star RM1600)

**Photo**

All dimensions in millimetres (nominal)

# 404MT/F

Long Run

## ROOFING PROFILE

Products: Lysaght Trimdek

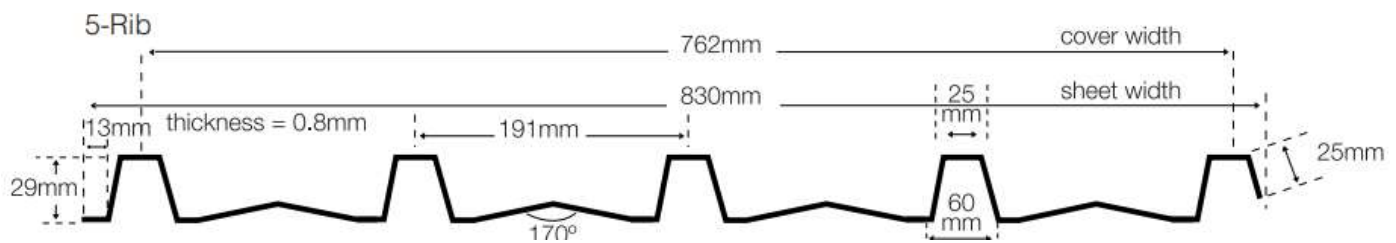
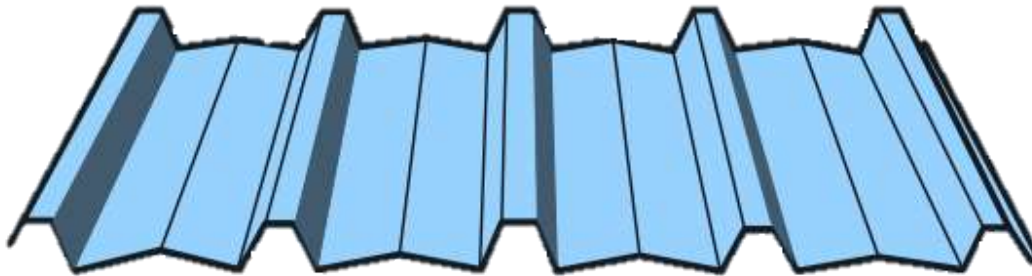

## FLASHING

**Homotech code:** 404MT/F-F  
with caps: 404MT/F

**Hole diameter:** Ø400  
(Suitable for 290DS Solatube,  
requires DSCOLLAR,  
suitable for Solar Star RM1600)



All dimensions in millimetres (nominal)

# 606MT

Long Run

## ROOFING PROFILE

Products: Lysaght Trimdek

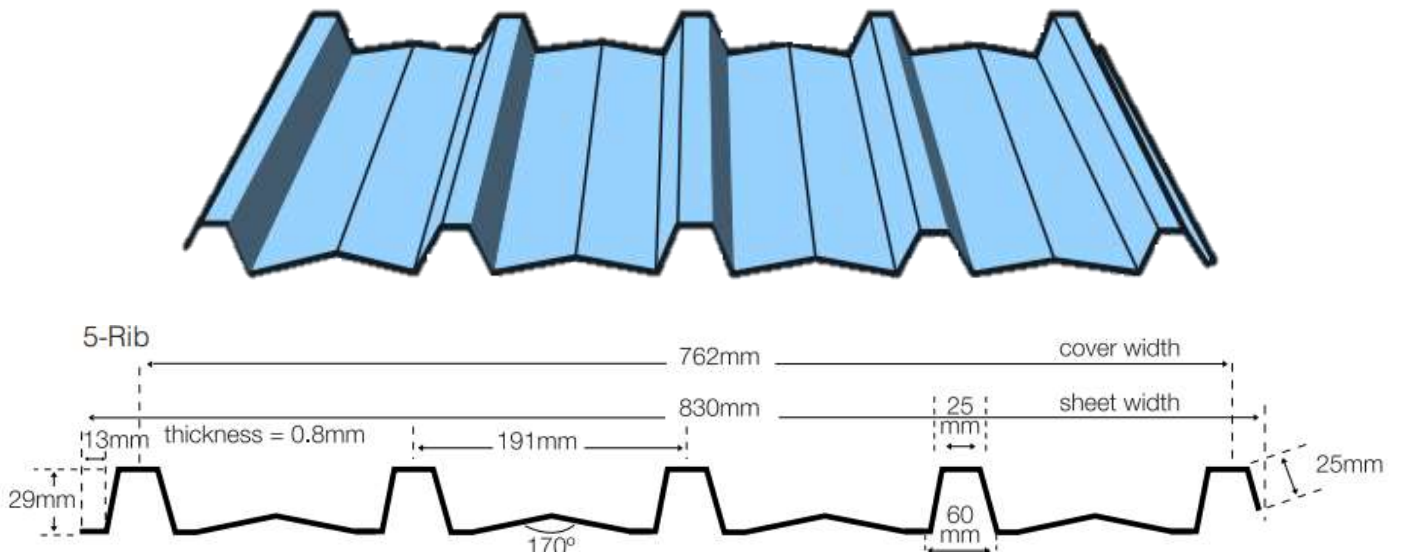

## FLASHING

**Homotech code:** 606MT-F  
with caps: 606MT

**Hole diameter:** Ø600  
(Suitable for 330DS, 750DS Solatube)

**Photo**

All dimensions in millimetres (nominal)



# 254KL15

Long Run

## ROOFING PROFILE

Product: Klip-lok



## FLASHING

Homotech code: 254KL15

Hole diameter:  $\varnothing 250$

(Suitable for 160DS Solatube,  
ED100/150/200 Duct reducer)



All dimensions in millimetres (nominal)



# 404KL15

Long Run

## ROOFING PROFILE

Product: Klip-lok

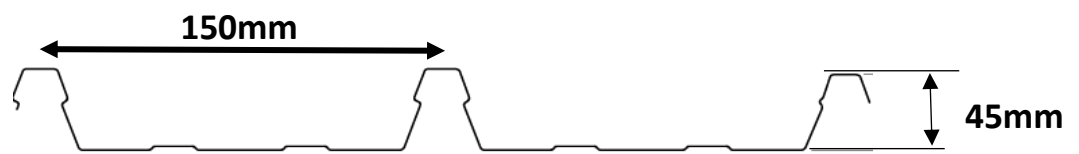

## FLASHING

Homotech code: 404KL15

**Hole diameter:  $\varnothing$ 400**  
(Suitable for 290DS Solatube,  
requires DSCOLLAR,  
suitable for Solar Star RM1600)



All dimensions in millimetres (nominal)

# 254MK

Long Run

## ROOFING PROFILE

**Product:** Lysaght Klip-lok 406  
Steel & Tube Kliplok

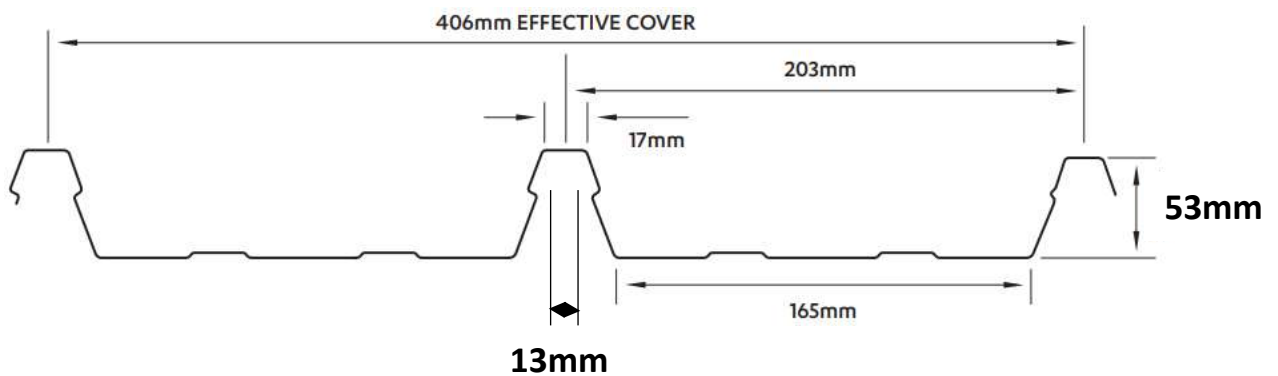

## FLASHING

**Homotech code:** 254MK

**Hole diameter:**  $\varnothing 250$   
(Suitable for 160DS Solatube,  
ED100/150/200 Duct reducer)

**Photo**

All dimensions in millimetres (nominal)

# 404MK

Long Run

## ROOFING PROFILE

**Product:** Lysaght Klip-lok 406  
Steel & Tube Kliplok

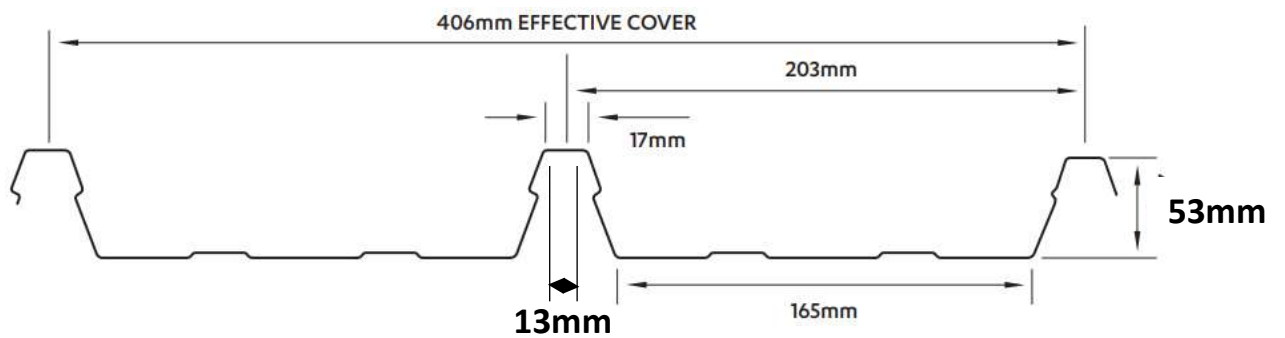

## FLASHING

**Homotech code:** 404MK

**Hole diameter:**  $\varnothing 400$   
(Suitable for 290DS Solatube,  
requires DSCOLLAR,  
suitable for Solar Star RM1600)



All dimensions in millimetres (nominal)

# 404KL23

Long Run

## ROOFING PROFILE

**Product:** Lysaght Klip-lok Classic 700  
Lysaght Klip-lok 700 Hi-Strength

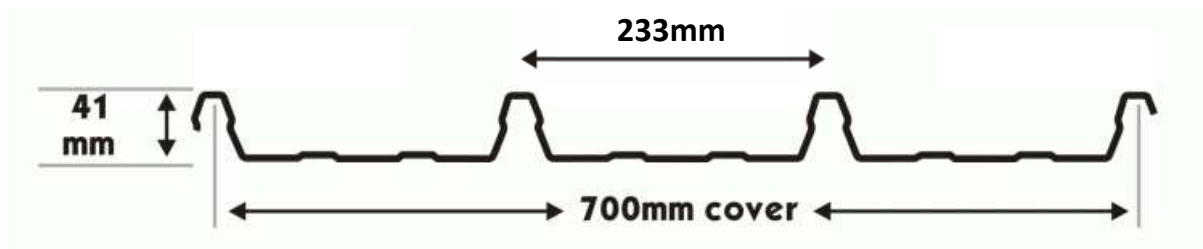

## FLASHING

**Homotech code:** 404KL23

**Hole diameter:**  $\varnothing 400$   
(Suitable for 290DS Solatube,  
requires DSCOLLAR,  
suitable for Solar Star RM1600)

**Photo**

All dimensions in millimetres (nominal)

# 254LUX

Long Run

## ROOFING PROFILE

**Product:** Besalon (Luxalon)

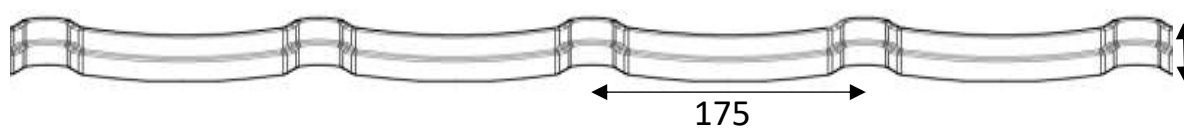

## FLASHING

**Homotech code:** 254LUX-F  
with corrugated caps: 254LUX

**Hole diameter:**  $\varnothing 250$   
(Suitable for 160DS Solatube,  
ED100/150/200 Duct reducer)



All dimensions in millimetres (nominal)

# 404LUX

Long Run

## ROOFING PROFILE

**Product:** Besalon (Luxalon)

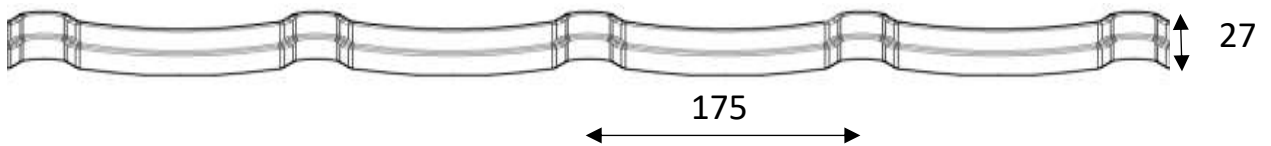

## FLASHING

**Homotech code:** 404LUX-F  
with caps: 404LUX

**Hole diameter:** Ø400  
(Suitable for 290DS Solatube,  
requires DSCOLLAR,  
suitable for Solar Star RM1600)



All dimensions in millimetres (nominal)

# 254125

Long Run

## ROOFING PROFILE

Product: Megaspan

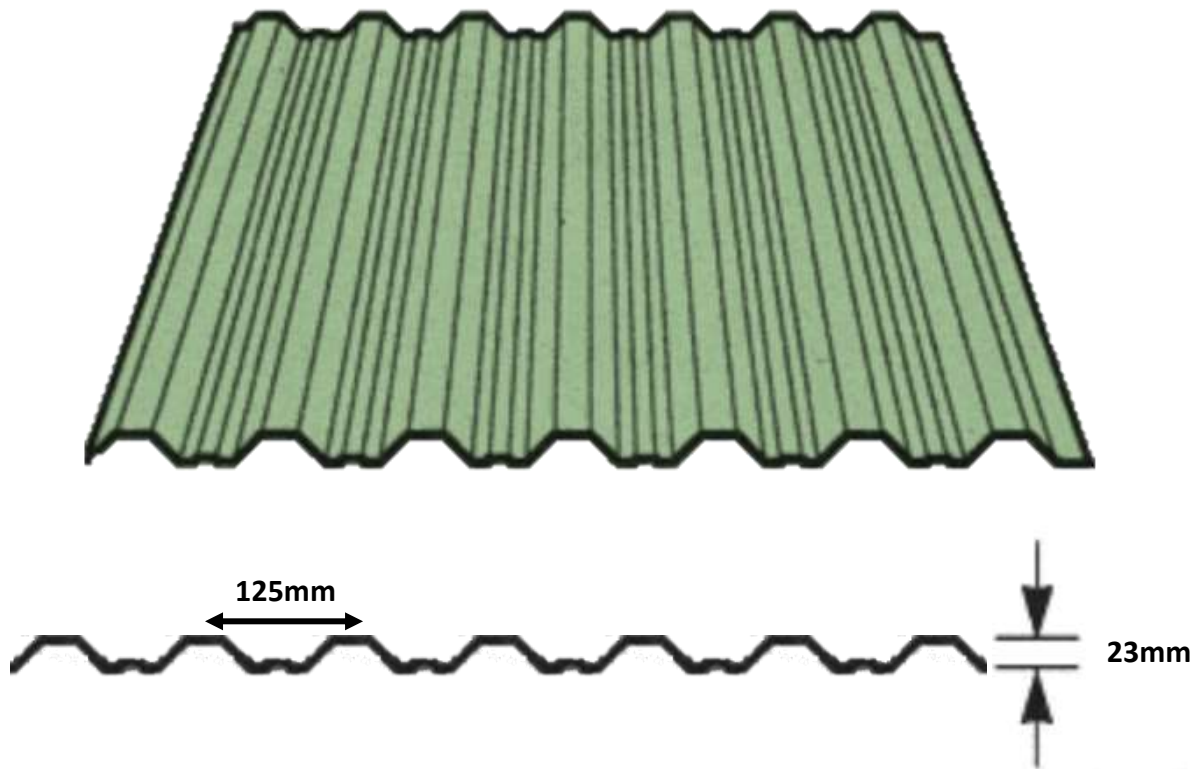

## FLASHING

Homotech code: 254125-F

With caps: 254125

Hole diameter  $\varnothing 250$   
(Suitable for 160DS Solatube,  
ED100/150/200 Duct reducer)

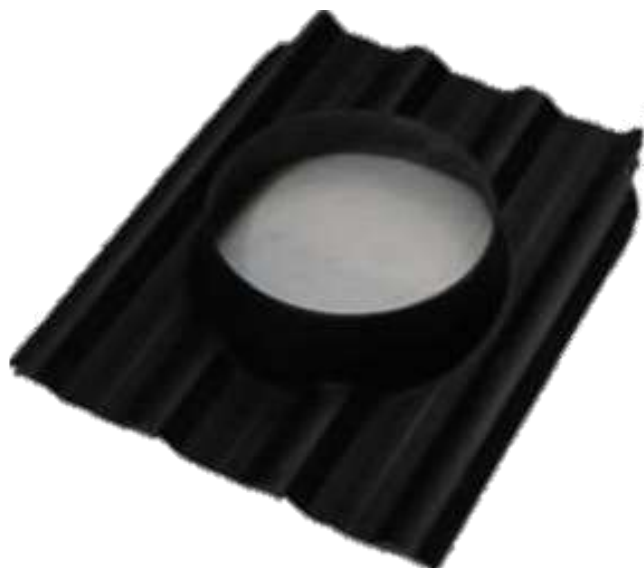

All dimensions in millimetres (nominal)

# 254191

Long Run

## ROOFING PROFILE

**Product:** Metalcraft MC760



## FLASHING

**Homotech code:** 254191-F  
with caps: 254191

**Hole diameter:** Ø250  
(Suitable for 160DS Solatube,  
ED100/150/200 Duct reducer)



All dimensions in millimetres (nominal)



# 404191

Long Run

## ROOFING PROFILE

**Product:** Metalcraft MC760



## FLASHING

**Homotech code:** 404191-F  
with caps: 404191

**Hole diameter** Ø400  
(Suitable for 290DS Solatube,  
requires DSCOLLAR,  
suitable for Solar Star RM1600)

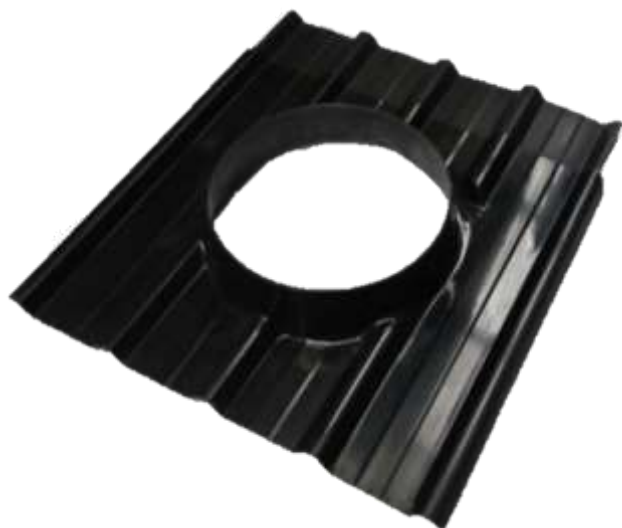

All dimensions in millimetres (nominal)

# 606191

Long Run

## ROOFING PROFILE

**Product:** Metalcraft MC760

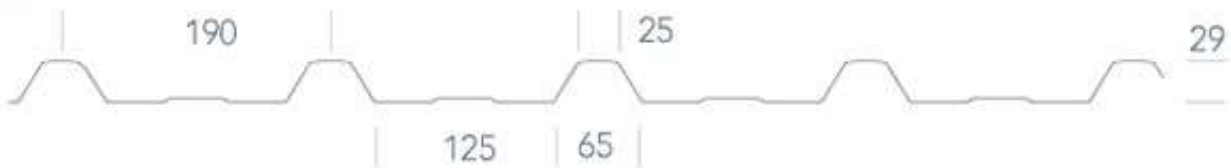

## FLASHING

**Homotech code:** 606191-F  
with caps: 606191

**Hole diameter**  $\varnothing 600$   
(Suitable for 330DS, 750DS  
Solatube)

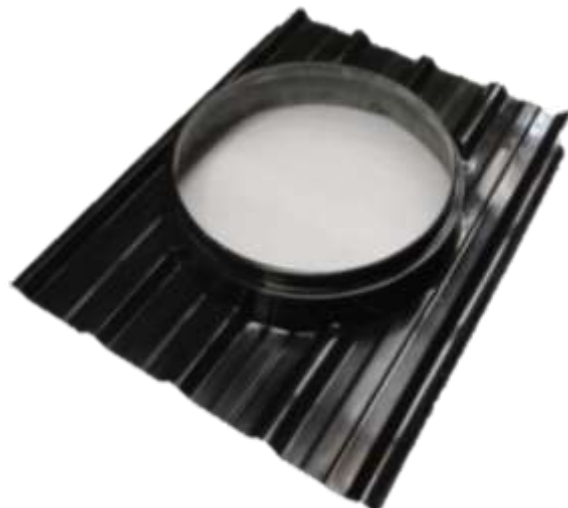

All dimensions in millimetres (nominal)

# 404192

Long Run

## ROOFING PROFILE

**Product:** Metalcraft MC770

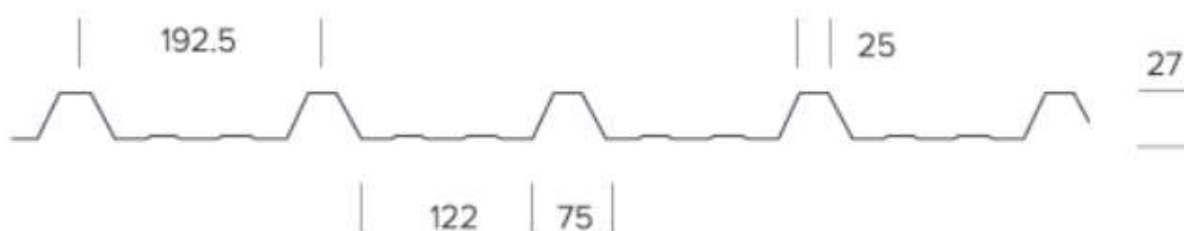

## FLASHING

**Homotech code:** 404192-F  
with caps: 404192

**Hole diameter:** Ø400  
(Suitable for 290DS Solatube,  
requires DSCOLLAR,  
suitable for Solar Star RM1600)

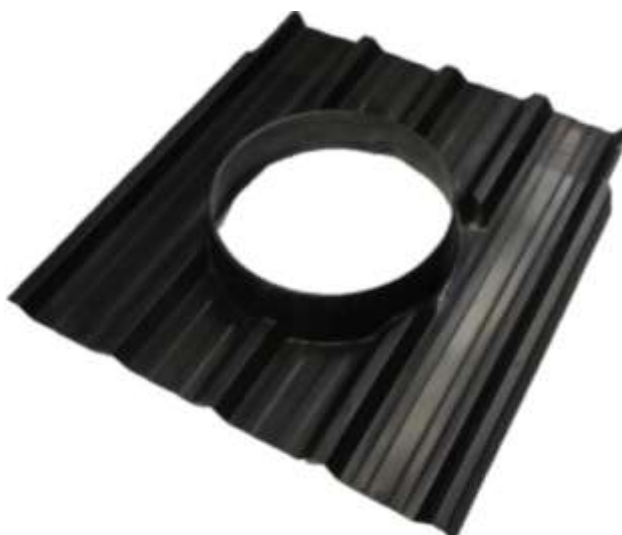

All dimensions in millimetres (nominal)

# 254233

Long Run

## ROOFING PROFILE

Product: Metalcraft Metcom 930

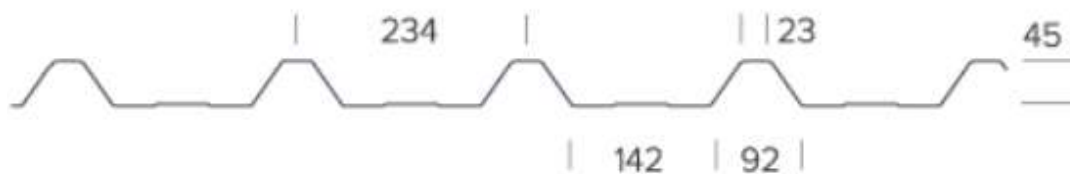
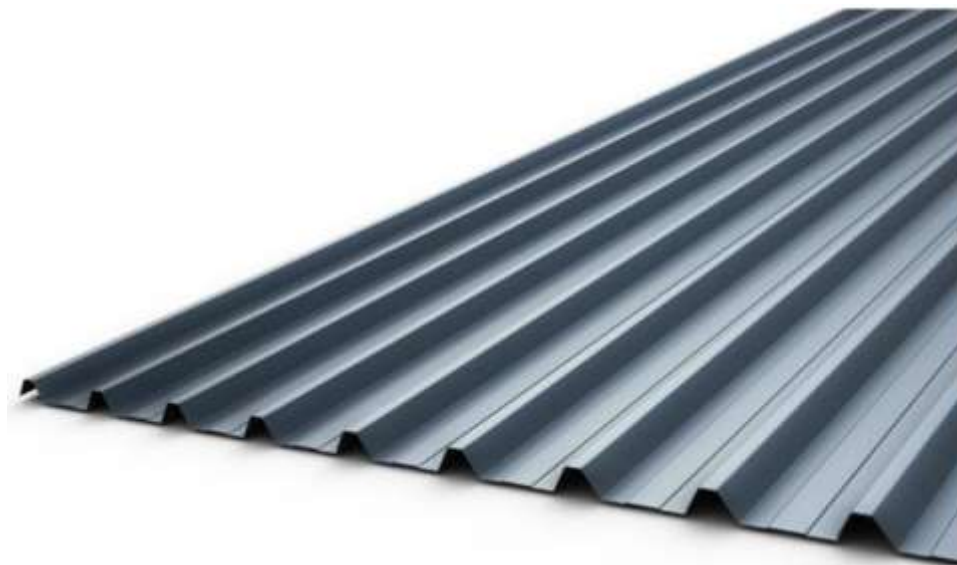

## FLASHING

Homotech code: 254233-F  
with caps: 254233

Hole diameter:  $\varnothing 250$   
(Suitable for 160DS Solatube,  
ED100/150/200 Duct reducer)

\*Extended  
Turret



All dimensions in millimetres (nominal)

# 254178

Long Run

## ROOFING PROFILE

**Product:** Metalcraft MC700



## FLASHING

**Homotech code:** 254178-F  
with caps: 254178

**Hole diameter:** Ø250  
(Suitable for 160DS Solatube,  
ED100/150/200 Duct reducer)



All dimensions in millimetres (nominal)

# 404178

Long Run

## ROOFING PROFILE

Product: Metalcraft MC700



## FLASHING

**Homotech code:** 404178-F  
with caps: 404178

**Hole diameter:**  $\varnothing 400$   
(Suitable for 290DS Solatube,  
requires DSCOLLAR,  
suitable for Solar Star RM1600)



All dimensions in millimetres (nominal)



# 254WIN

Long Run

## ROOFING PROFILE

**Product:** Unknown



## FLASHING

**Homotech code:** 254WIN  
with caps: 254WIN-F

**Hole diameter:** Ø250  
(Suitable for 160DS Solatube,  
ED100/150/200 Duct reducer)

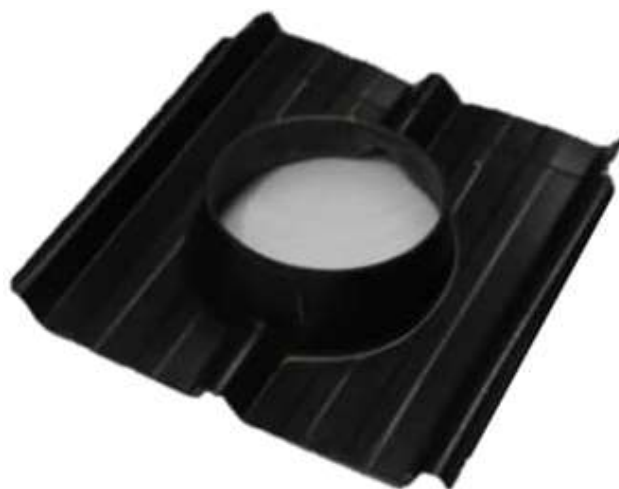

All dimensions in millimetres (nominal)

# 404WIN

Long Run

## ROOFING PROFILE

**Product:** Unknown

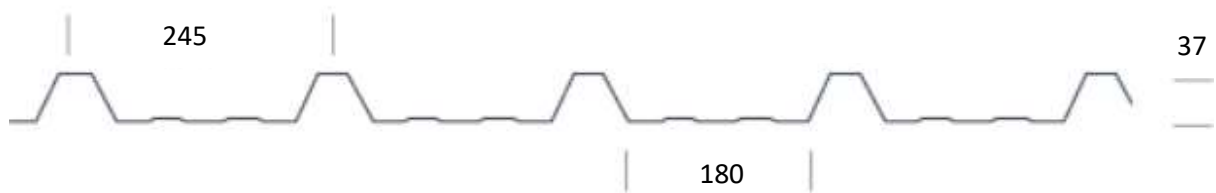

## FLASHING

**Hometech code:** 404WIN  
with caps: 404WIN-F

**Hole diameter:** Ø400  
(Suitable for 290DS Solatube,  
requires DSCOLLAR,  
suitable for Solar Star RM1600)

**Photo**

All dimensions in millimetres (nominal)



# 254TL

Long Run

## ROOFING PROFILE

**Product:** Taranaki Steelformers Ribline



## FLASHING

**Homotech code:** 254TL-F  
with caps: 254TL

**Hole diameter:** Ø250  
(Suitable for 160DS Solatube,  
ED100/150/200 Duct reducer)



All dimensions in millimetres (nominal)

# 404TL

Long Run

## ROOFING PROFILE

**Product:** Taranaki Steelformers Ribline

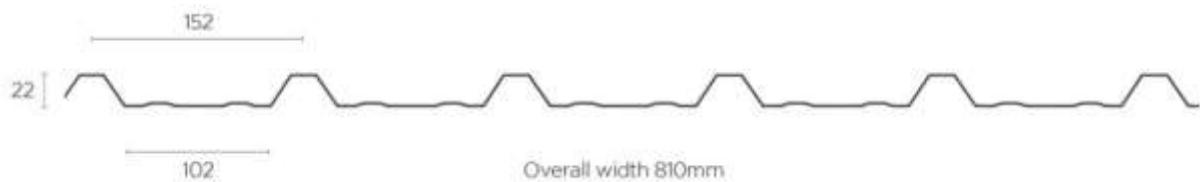

## FLASHING

**Hometech code:** 404TL-F  
with caps: 404TL

**Hole diameter:** Ø400  
(Suitable for 290DS Solatube,  
requires DSCOLLAR,  
suitable for Solar Star RM1600)



All dimensions in millimetres (nominal)

# 404235

Long Run

## ROOFING PROFILE

**Product:** Unknown

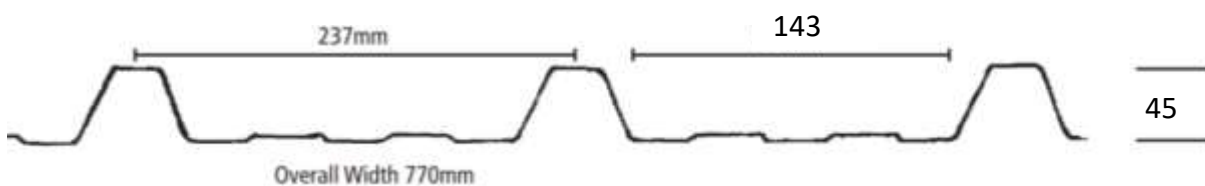
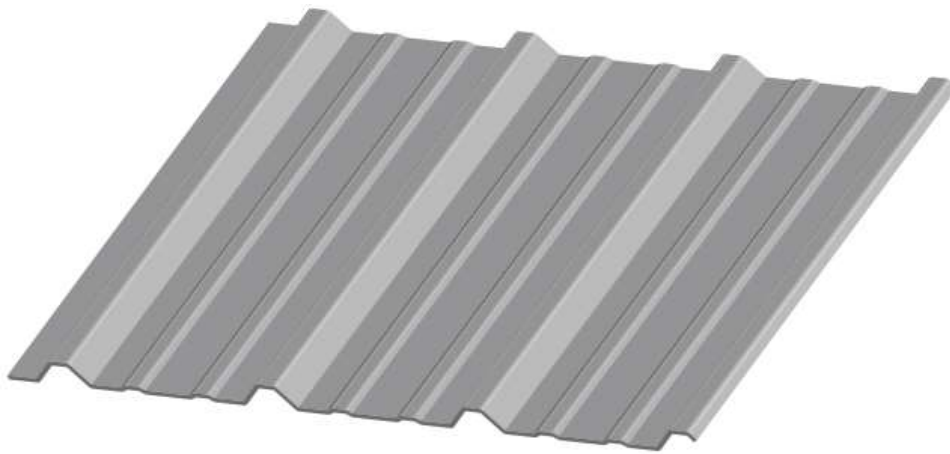

## FLASHING

**Homotech code:** 404235-F

With caps: 404235

**Hole diameter**  $\varnothing$ 400

(Suitable for 290DS Solatube,  
requires DSCOLLAR,  
suitable for Solar Star RM1600)

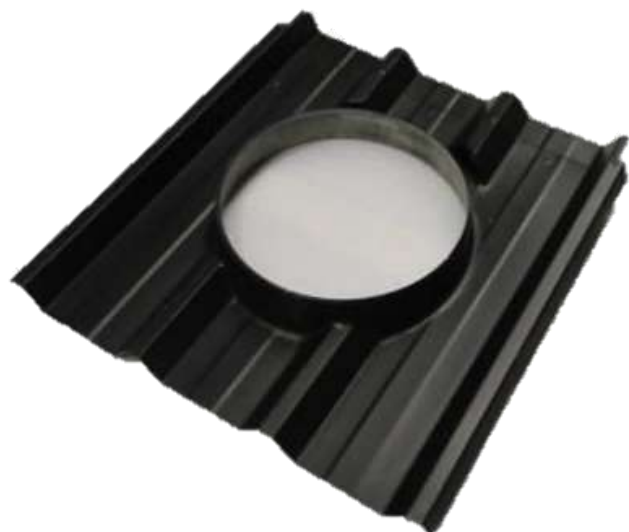

All dimensions in millimetres (nominal)

# 254MC

Long Run

## ROOFING PROFILE

**Product:** Corrugated



## FLASHING

**Homotech code:** 254MC

**Hole diameter:** Ø250  
(Suitable for 160DS Solatube,  
ED100/150/200 Duct reducer)

**Polypropylene**

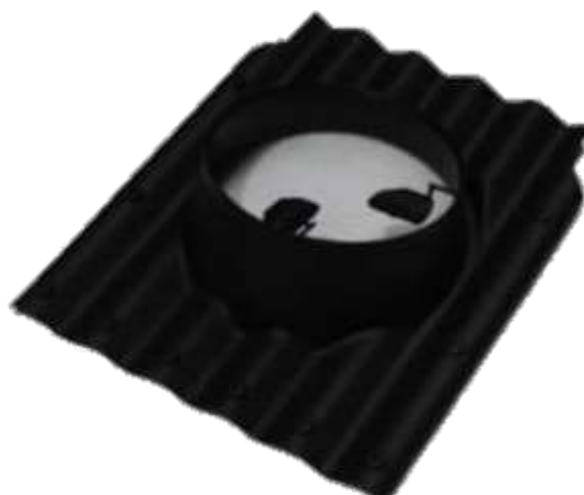

All dimensions in millimetres (nominal)

# FL-290DS/MC

Long Run

## ROOFING PROFILE

Product: Corrugated



## FLASHING

Homotech code: FL-290DS/MC

Hole diameter: Ø350  
(Suitable for 290DS Solatube,  
suitable for Solar Star RM1600)



All dimensions in millimetres (nominal)

# 404MC

Long Run

## ROOFING PROFILE

**Product:** Corrugated



## FLASHING

**Homotech code:** 404MC

**Hole diameter:**  $\varnothing$ 400

(Suitable for 290DS Solatube, requires DSCOLLAR, suitable for Solar Star RM1600)

**Polypropylene**

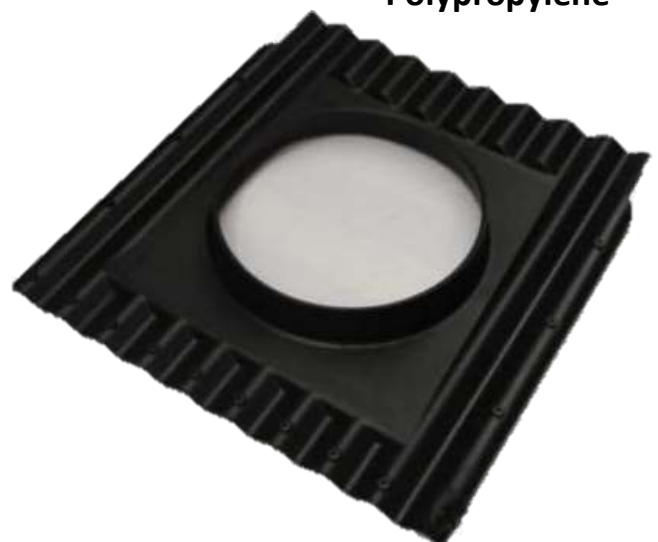

All dimensions in millimetres (nominal)

# 606MC

Long Run

## ROOFING PROFILE

**Product:** Corrugated



## FLASHING

**Hometech code:** 606MC

**Hole diameter:** Ø600  
(Suitable for 330DS, 750DS  
Solatube)

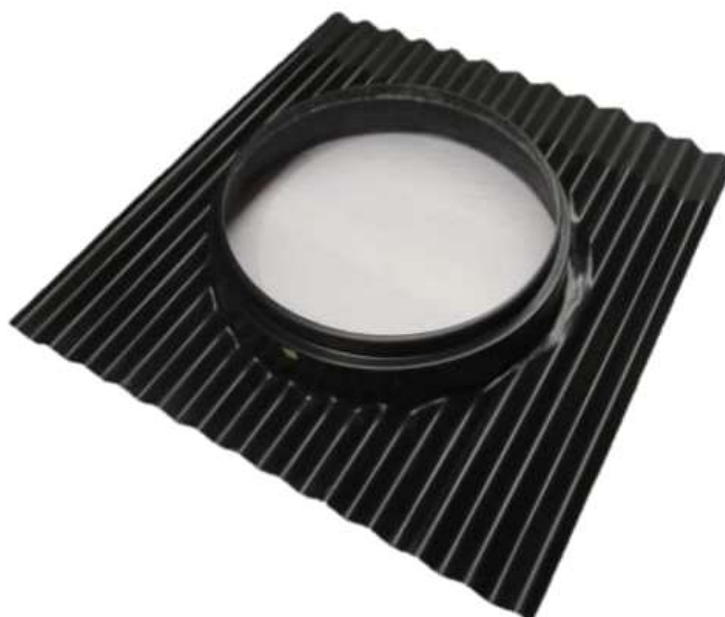

All dimensions in millimetres (nominal)

## ROOFING PROFILE

**Product:** Roofing Industries True Oak

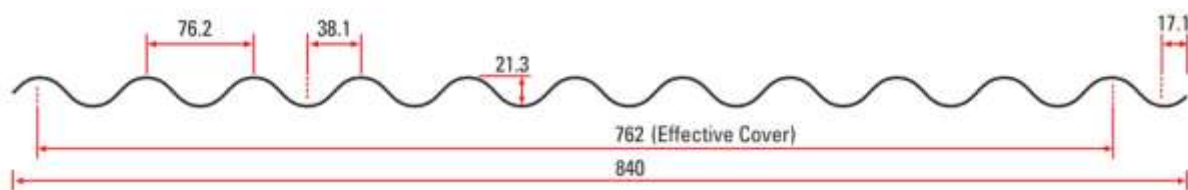
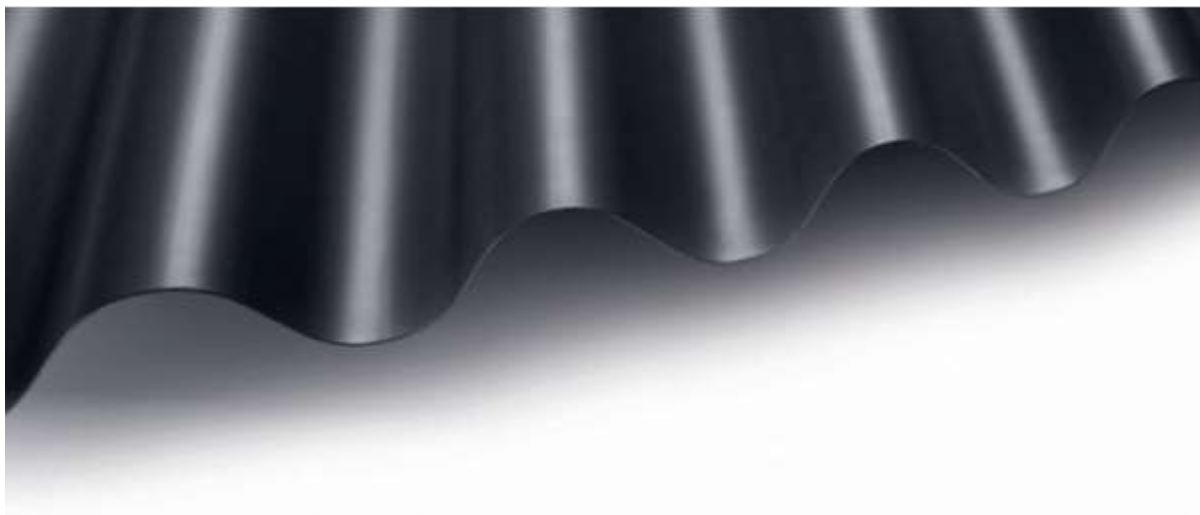

## FLASHING

**Homotech code:** 254TO

**Hole diameter:**  $\varnothing 250$   
(Suitable for 160DS Solatube,  
ED100/150/200 Duct reducer)



All dimensions in millimetres (nominal)



## ROOFING PROFILE

**Product:** Roofing Industries True Oak

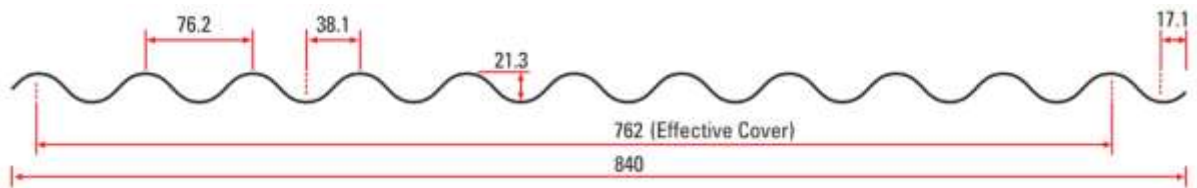
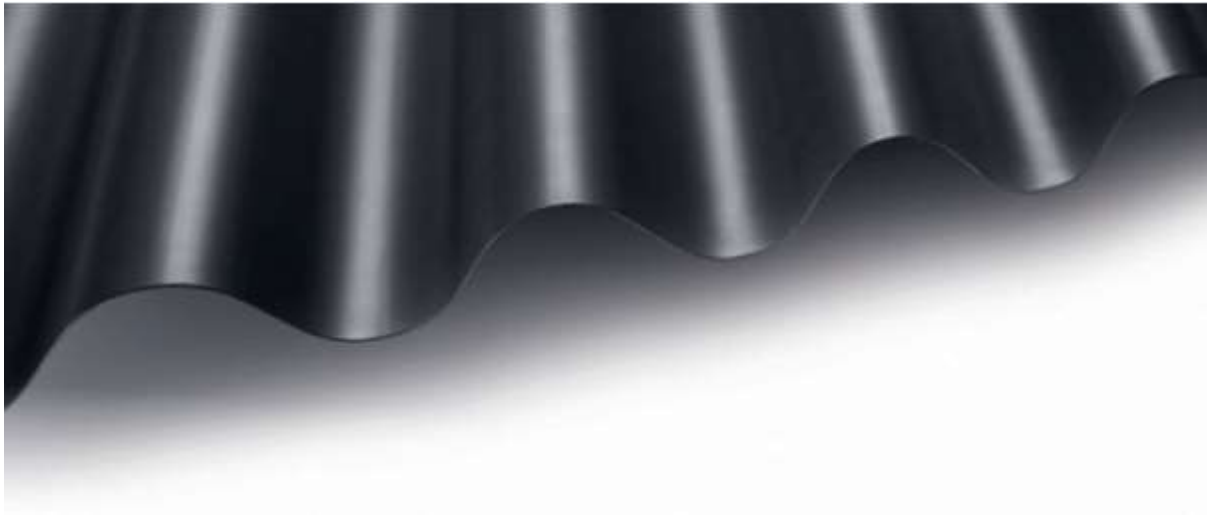

## FLASHING

**Hometech code:** 404TO

**Hole diameter:** Ø350  
(Suitable for 290DS Solatube,  
suitable for Solar Star RM1600)



All dimensions in millimetres (nominal)

## ROOFING PROFILE

**Product:** Steel & Tube ST7

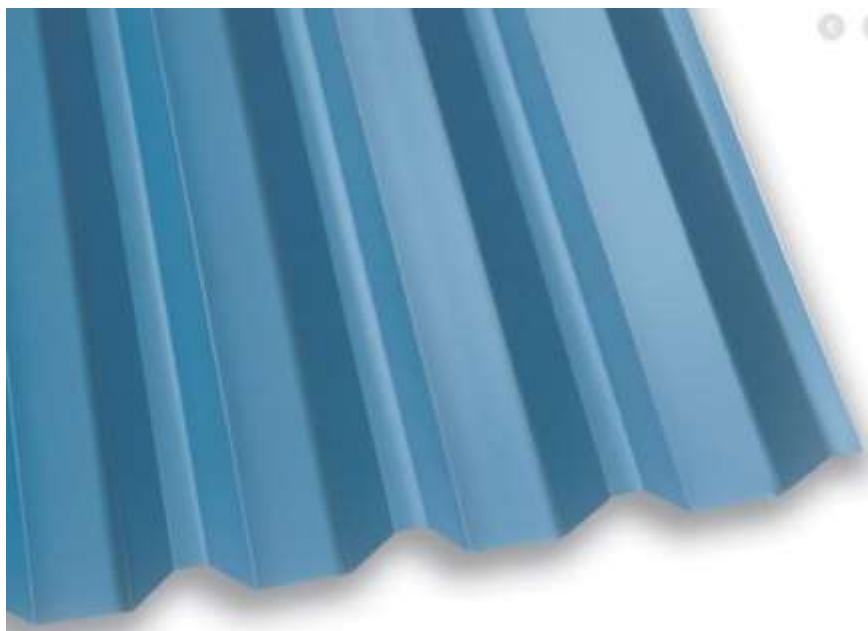

### NOMINAL DIMENSIONS

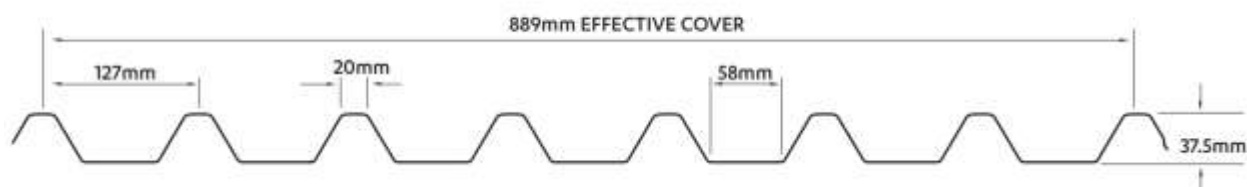

## FLASHING

**Hometech code:** 254ST7

**Hole diameter:**  $\varnothing 250$   
(Suitable for 160DS Solatube,  
ED100/150/200 Duct reducer)

**Photo**

All dimensions in millimetres (nominal)

# 254192

added December 2019

Long Run

## ROOFING PROFILE

**Product:** Metalcraft MC770

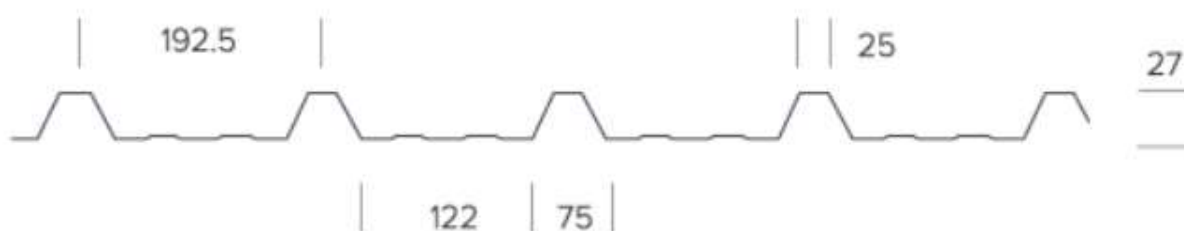

## FLASHING

**Homotech code:** 254192-F  
with caps: 254192

**Hole diameter:** Ø250  
(Suitable for 160DS Solatube,  
ED100/150/200 Duct reducer)

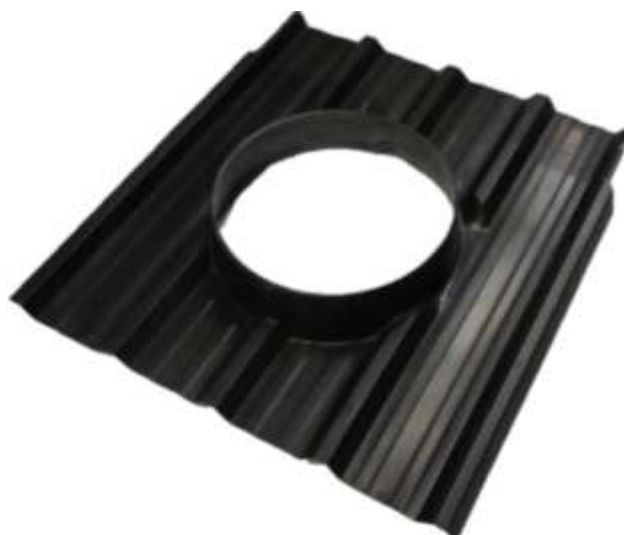

All dimensions in millimetres (nominal)

D

# Flat Roof Profile

# 254S90

## Flat Roof Profile

### ROOFING PROFILE

**Product:** Tray Flashing  
Asphalt Shingle

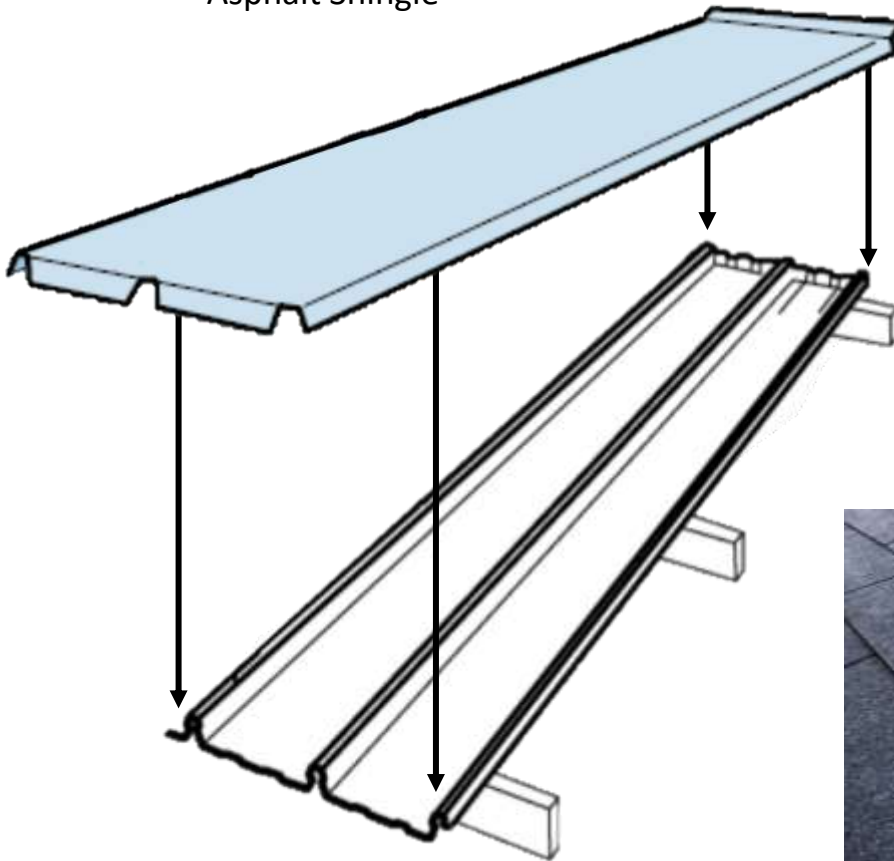

**NOTE:** Any roofing profile under 5° pitch is required to be tray flashed.



### FLASHING

**Homotech code:** 254S90

**Hole diameter:** Ø250  
(Suitable for 160DS Solatube,  
ED100/150/200 Duct reducer)



**Fibreglass**

All dimensions in millimetres (nominal)

# FL-210030

## Flat Roof Profile

### ROOFING PROFILE

**Product:** Tray Flashing  
Asphalt Shingle

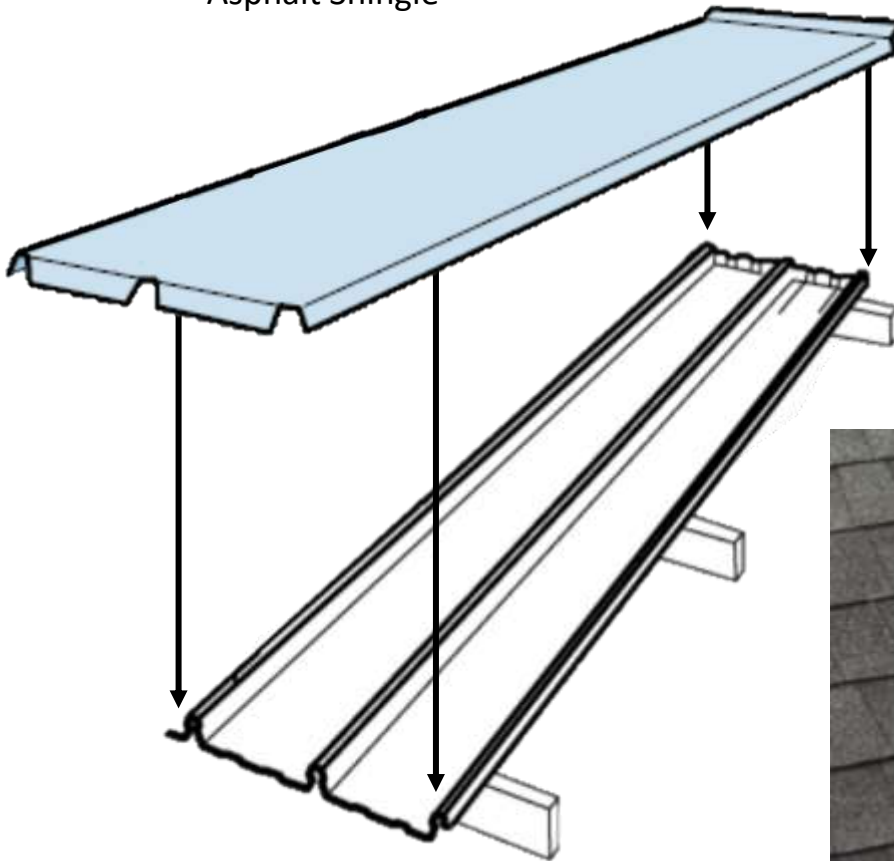

**NOTE:** Any roofing profile under 5° pitch is required to be tray flashed.



### FLASHING

**Homotech code:** FL-210030

**Hole diameter:** Ø250  
(Suitable for 160DS Solatube,  
ED100/150/200 Duct reducer)



**Steel**

All dimensions in millimetres (nominal)

# 404S90

## Flat Roof Profile

### ROOFING PROFILE

**Product:** Tray Flashing  
Asphalt Shingle

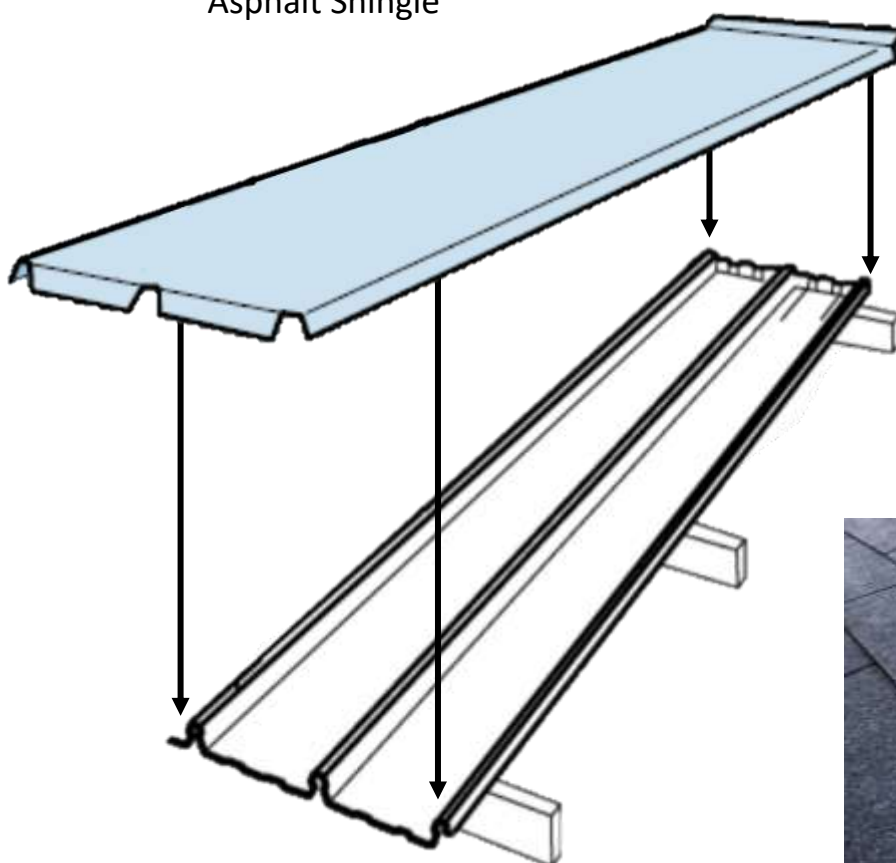

**NOTE:** Any roofing profile under 5° pitch is required to be tray flashed.



### FLASHING

**Hometech code:** 404S90

**Hole diameter:** Ø400  
(Suitable for 290DS Solatube,  
requires DSCOLLAR,  
suitable for Solar Star RM1600)

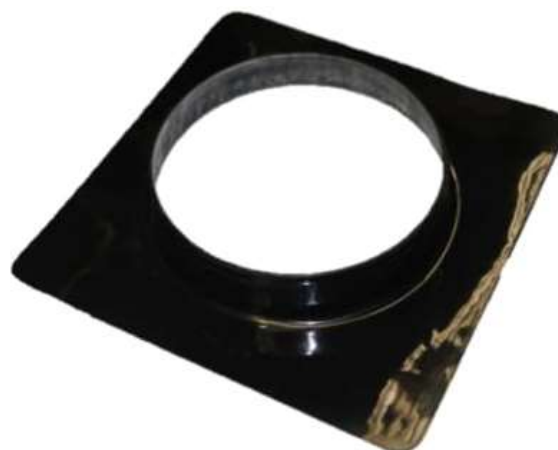

All dimensions in millimetres (nominal)



# 606S90

## Flat Roof Profile

### ROOFING PROFILE

**Product:** Tray Flashing  
Asphalt Shingle

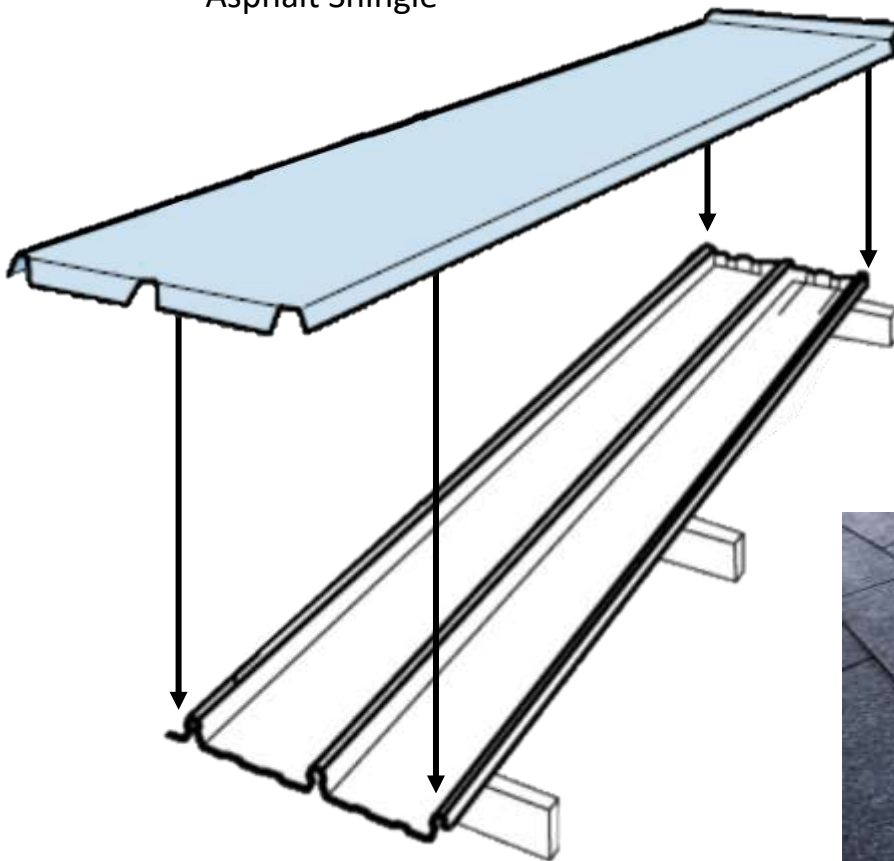

**NOTE:** Any roofing profile under 5° pitch is required to be tray flashed.



### FLASHING

**Homotech code:** 606S90

**Hole diameter:** Ø600  
(Suitable for 330DS, 750DS  
Solatube)



All dimensions in millimetres (nominal)



# 254S

## Flat Roof Profile

### ROOFING PROFILE

**Product:** Steep angle Tray Flashing  
Asphalt Shingle

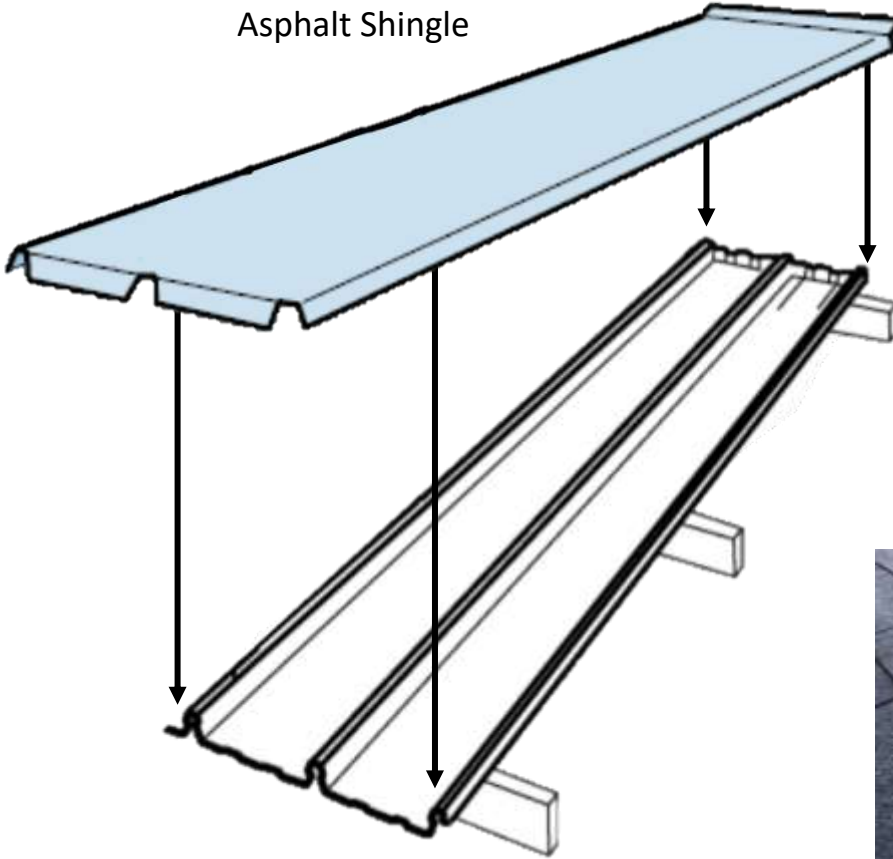

**NOTE:** Any roofing profile under 5° pitch is required to be tray flashed.



### FLASHING

**Hometech code:** 254S

**Hole diameter:** Ø250  
(Suitable for 160DS Solatube,  
ED100/150/200 Duct reducer)



All dimensions in millimetres (nominal)

**E**

**Butynol Membrane**

# 254UAF

## Butynol Membrane

### ROOFING PROFILE

**Product:** Butynol Membrane Finish

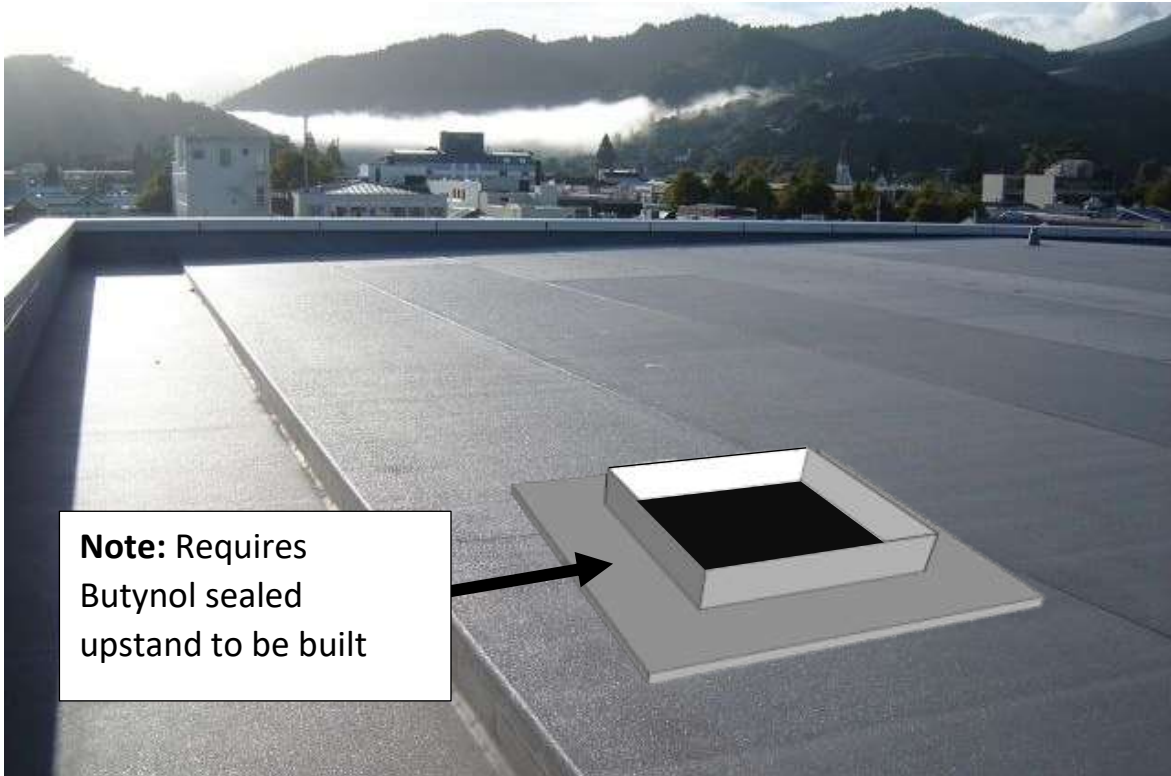

### FLASHING

**Homotech code:** 254UAF

**Hole diameter:**  $\varnothing 250$   
(Suitable for 160DS Solatube,  
ED100/150/200 Duct reducer)

Polypropylene

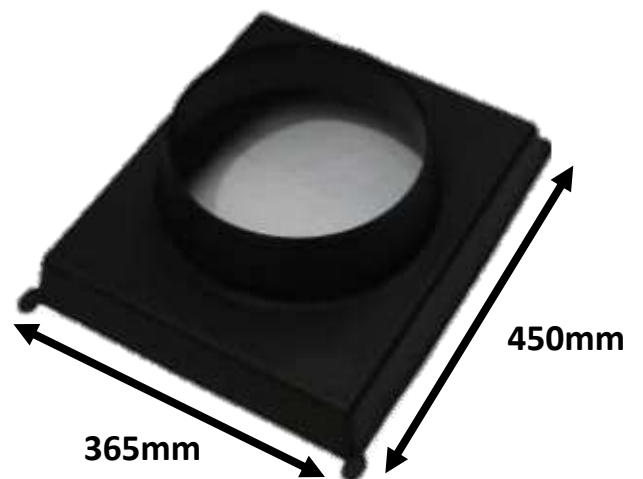

All dimensions in millimetres (nominal)

# FL-290DS/MUG

Butynol Membrane

## ROOFING PROFILE

**Product:** Butynol Membrane Finish

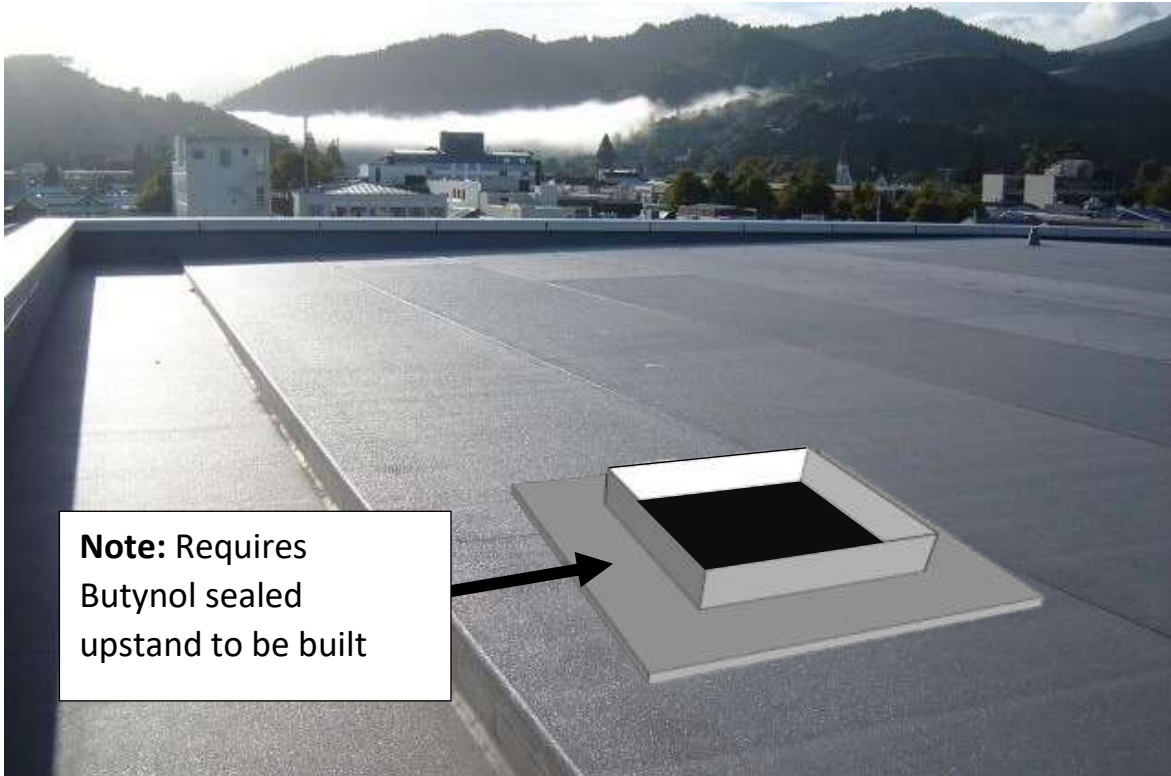

## FLASHING

**Homotech code:** FL-290DS/MUG

**Hole diameter:**  $\varnothing 350$   
(Suitable for 290DS Solatube,  
suitable for Solar Star RM1600)

Polypropylene

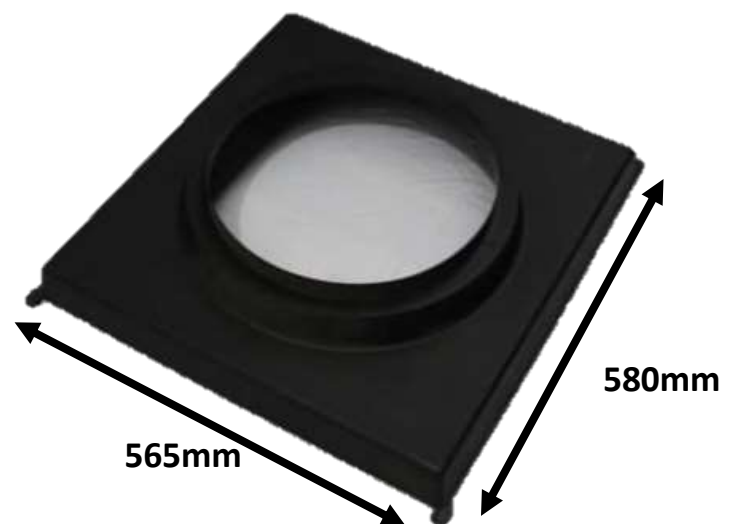

All dimensions in millimetres (nominal)

E3

# 404UAF

## Butynol Membrane

### ROOFING PROFILE

**Product:** Butynol Membrane Finish

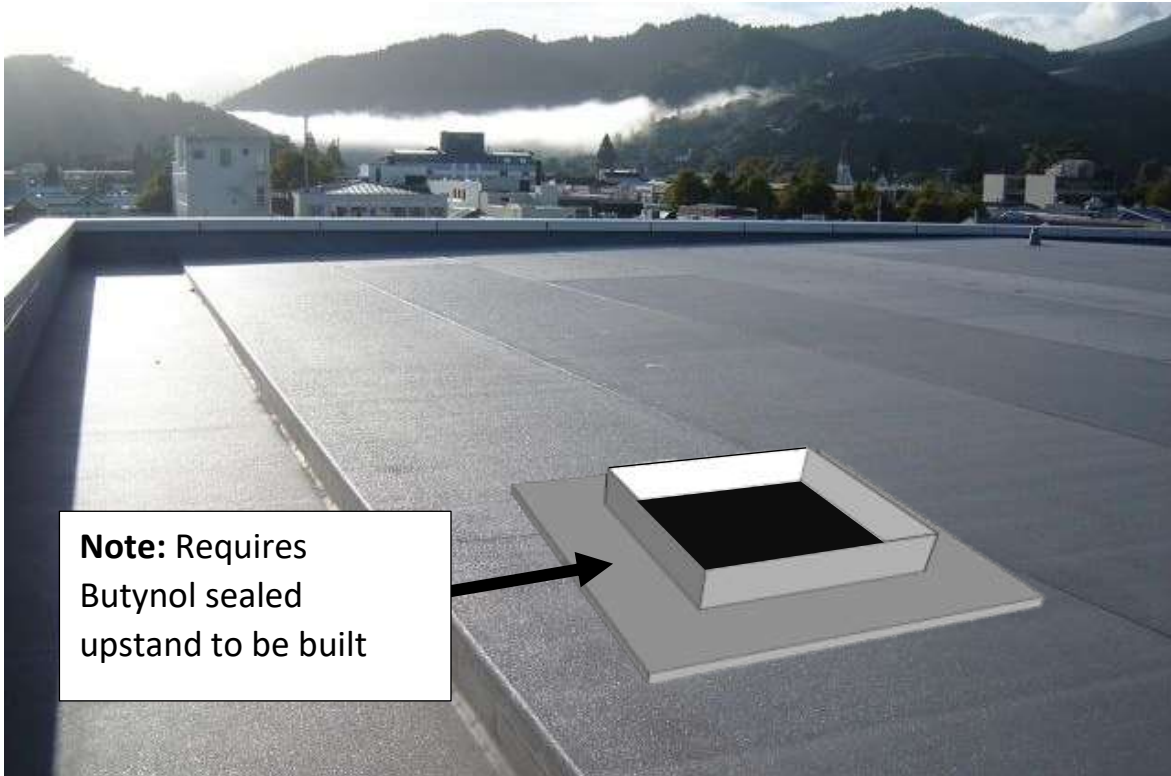

### FLASHING

**Hometech code:** 404UAF

**Hole diameter:**  $\varnothing 400$   
(Suitable for 290DS Solatube,  
requires DSCOLLAR,  
suitable for Solar Star RM1600)

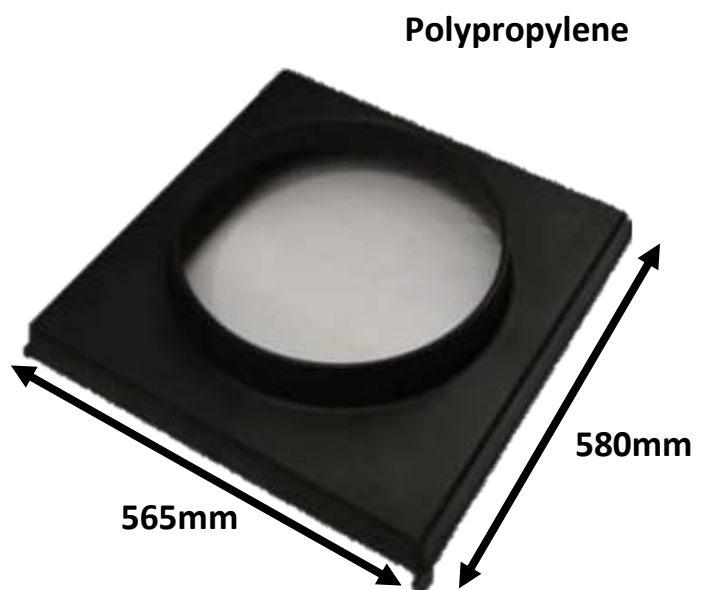

All dimensions in millimetres (nominal)

# 606UAF

Butynol Membrane

## ROOFING PROFILE

**Product:** Butynol Membrane Finish

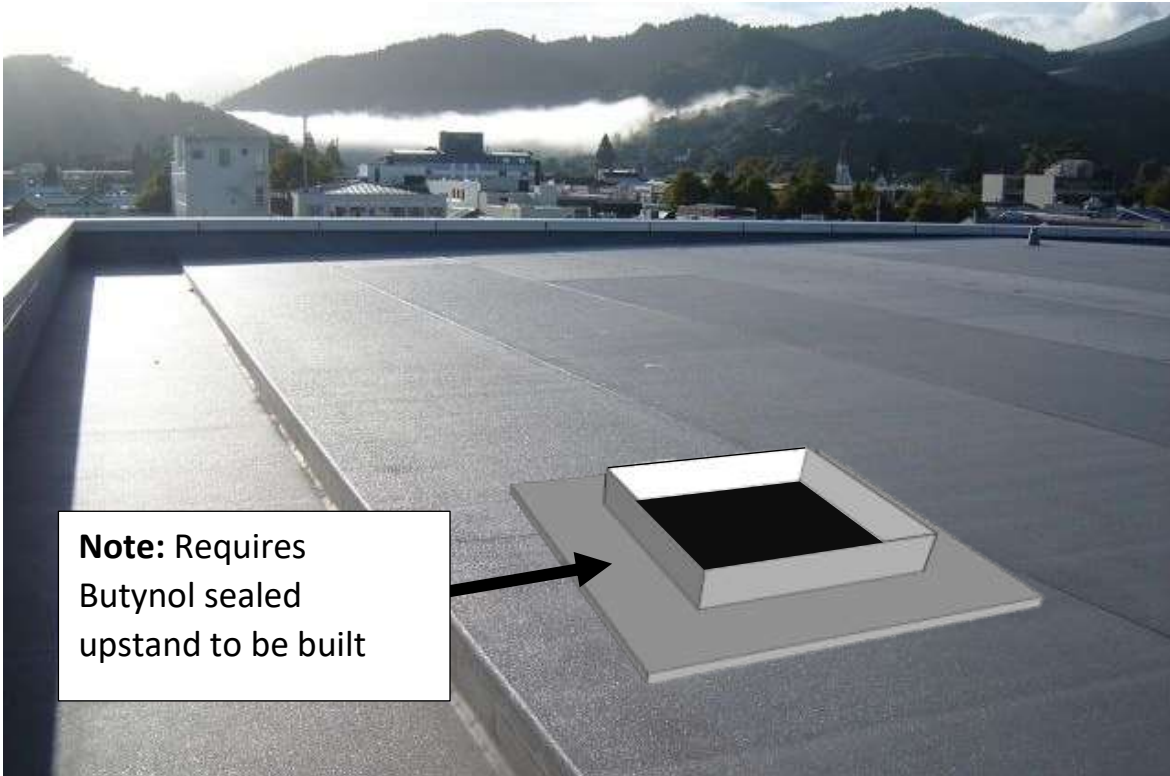

## FLASHING

**Homotech code:** 606UAF

**Hole diameter**  $\varnothing$ 550  
(Suitable for 330DS, 750DS Solatube)

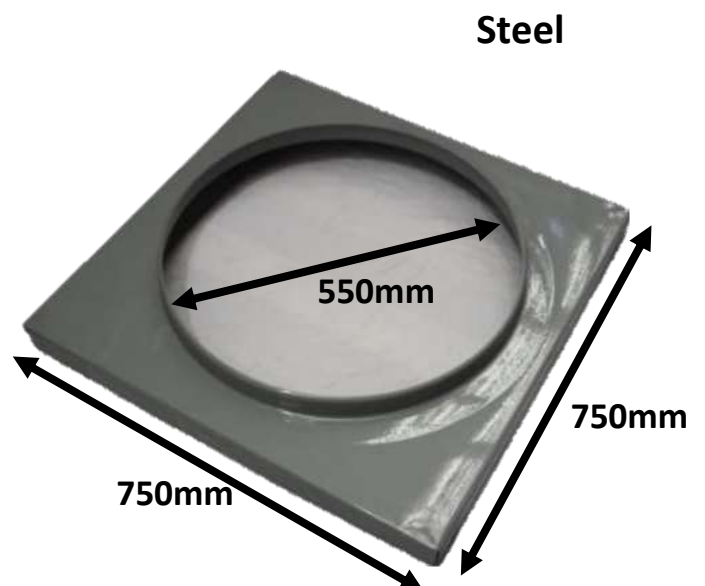

All dimensions in millimetres (nominal)

F

Flashing Add-ons



## DSCOLLAR – 290DS Adapter Ring

Flashing add-ons

### FLASHING PROFILE

**Homotech Flashing:** Suitable with any  $\varnothing 400$  hole flashing



### FLASHING ADD-ON

**Homotech code:** DSCOLLAR

**Hole diameter:**  $\varnothing 350$

(Suitable for 290DS Solatube, suitable for Solar Star RM1600)



**290DS Adapter Ring**

All dimensions in millimetres (nominal)



## 25TR - Extender Turret Ring

Flashing add-ons

### FLASHING PROFILE

**Homotech Flashing:** Suitable with any  $\varnothing 250$  hole flashing



### FLASHING ADD-ON

**Homotech code:** 25TR

**Hole diameter:**  $\varnothing 250$   
(Suitable for 160DS Solatube,  
ED100/150/200 Duct reducer)



**250mm Extender Turret Ring**

All dimensions in millimetres (nominal)